

Multipole plug with cable, series CON-MP



AVENTICS™ Multipole plug with cable, series CON-MP



Multipole plug, series CON-MP

- Socket C/2 48-pin angled 45°
- with cable
- unshielded



Ambient temperature min./max.	0 ... 50 °C
Operational voltage	24 V DC
Protection class	IP69K
Wire cross-section	0.34 mm ²
Weight	See table below

Technical data

Part No.	Electrical connection	Max. current	Number of wires	Cable-Ø	Cable length	Weight	
	2						
0493871009	open cable ends 24-pin	3 A	25	11.1 mm	5 m	1 kg	1)
0493871203	open cable ends 24-pin	3 A	25	11.1 mm	10 m	1.994 kg	1)
0493871408	open cable ends 24-pin	3 A	25	11.1 mm	15 m	2.84 kg	1)
0493871106	open cable ends 48-pin	3 A	40	13.5 mm	5 m	1.483 kg	2)
0493871300	open cable ends 48-pin	3 A	40	13.5 mm	10 m	2.948 kg	2)
0493871505	open cable ends 48-pin	3 A	40	13.5 mm	15 m	4.277 kg	2)

- 1) max. 8 valves
- 2) max. 16 valves

Technical information

Material	
Housing	Polyamide
Cable sheath	Polyvinyl chloride

Dimensions

Dimensions

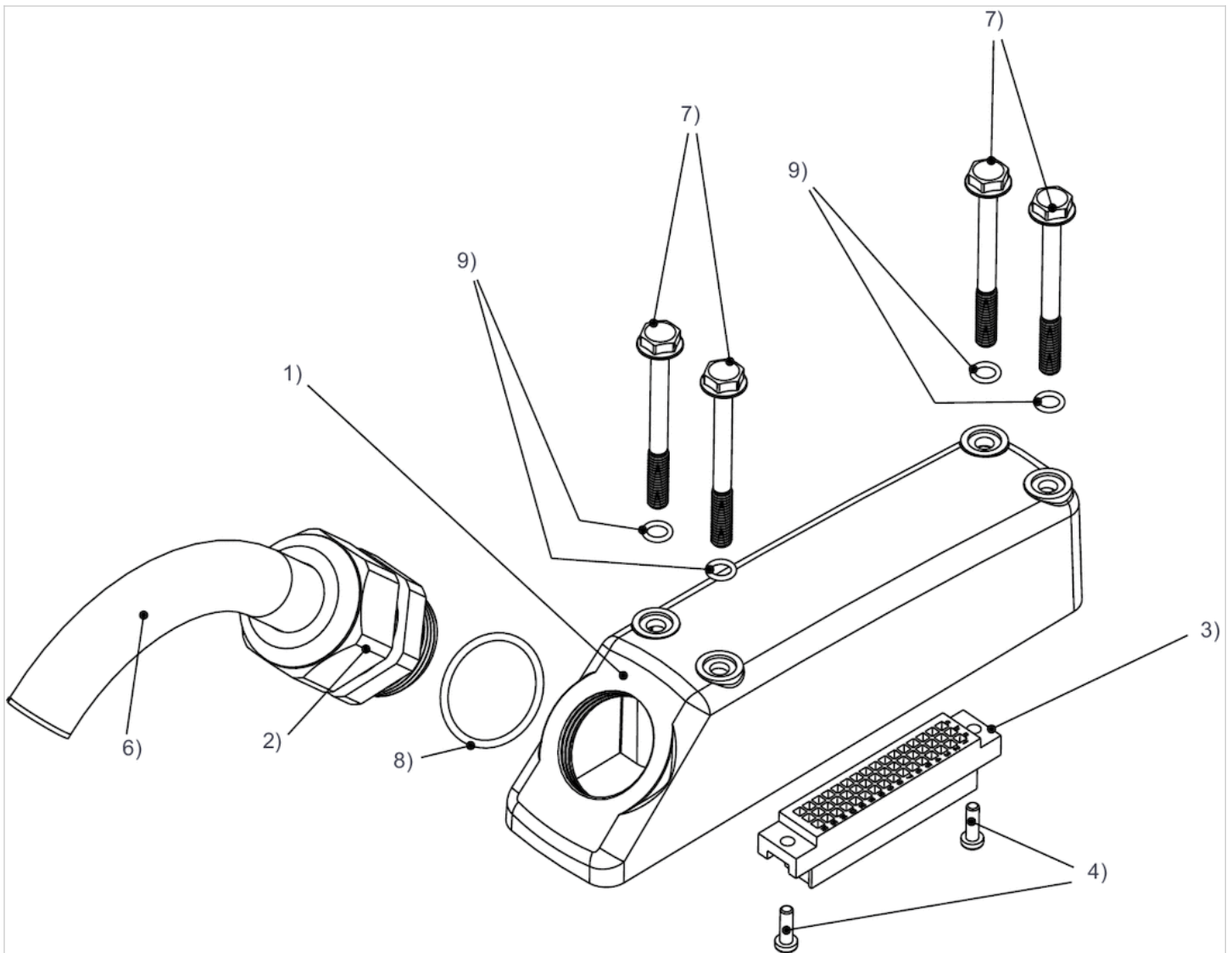

1) housing 2) cable gland 3) connector housing size C/2 4) screw 5) seal 6) cable 7) screw 8) seal 9) seal

Pin assignments

PIN assignment and cable colors



Pin	A1	A2	A3	A4	A5	A6
Color	blue	red/blue	white/pink	pink/brown	white/blue	brown/blue

A7	A8	B1	B2	B3	B4	B5	B6
white/red	brown/red	white	green	gray	red	violet	white/green

B7	B8	C1	C2	C3	C4	C5
white/yellow	white/gray	brown	yellow	pink	black	gray/pink

C6	C7	C8
brown/green	yellow/brown	gray/brown

Pin	A2	A3	A4	A5	A6	A7
Color	red/blue	white/pink	brown/blue	white/blue	brown/blue	white/red

A8	A9	B1	B2	B3	B4	B5	B6
brown/red	blue	white	green	gray	red	violet	white/green

B7	B8	B9	B10	B11	B12
white/yellow	white/gray	white/pink	white/red	white/black	gray/green

B13	B14	B15	B16	C1	C2	C3	C4
pink/green	green/red	green/black	gray/red	brown	yellow	pink	black

C5	C6	C7	C8	C9	C10
gray/pink	brown/green	yellow/brown	gray/brown	pink/brown	brown/red

C11	C12	C13	C14	C15	C16
brown/black	yellow/gray	yellow/pink	yellow/red	yellow/black	pink/red

Multipole plug, series CON-MP

- Socket D-Sub 25-pin angled 90°
- open cable ends 25-pin
- with cable
- suitable for dynamic laying
- unshielded



Ambient temperature min./max.	-5 ... 50 °C
Operational voltage	24 V DC
Protection class	IP20
Wire cross-section	0.25 mm ²
Weight	See table below

Technical data

Part No.	Max. current	Number of wires	Cable-Ø	Cable length	Weight
R402000782	3 A	25	10.1 mm	3 m	0.487 kg
R402000783	3 A	25	10.1 mm	10 m	1.411 kg

suitable for dynamic laying

Technical information

The specified protection class is only valid in assembled and tested state.

Technical information

Material	
Housing	metal
Cable sheath	Polyvinyl chloride

Dimensions

Dimensions

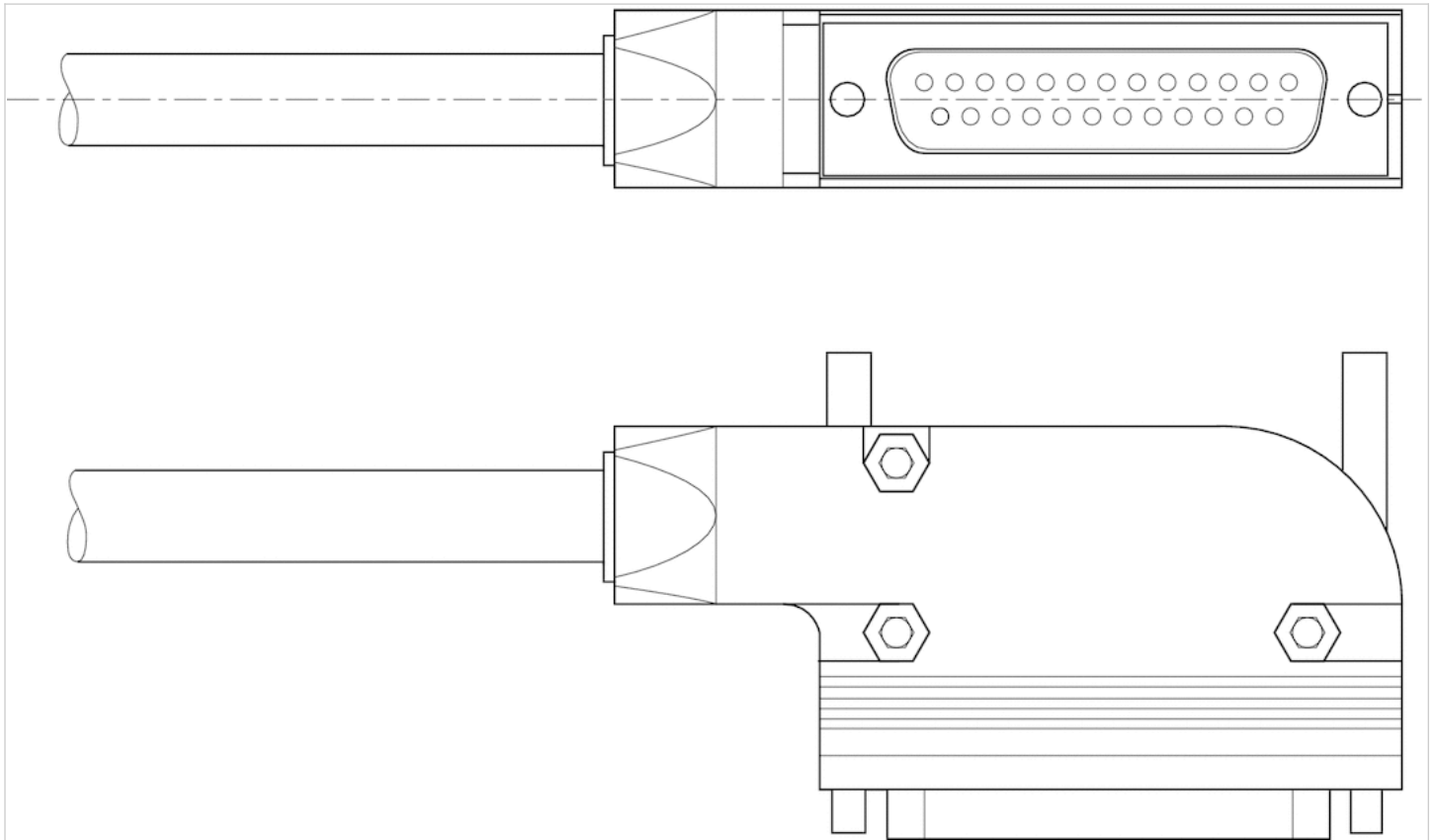

Pin assignments

PIN assignment and cable colors, cable identification as per DIN 7100

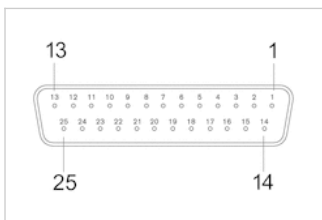

Socket

Pin	1	2	3	4	5	6	7	8	9
Color	white	brown	green	yellow	gray	pink	blue	red	black
10	11	12	13	14	15				
violet	gray/pink	red/blue	white/green	brown/green	white/yellow				
16	17	18	19	20	21				
yellow/brown	white/gray	gray/brown	white/pink	pink/brown	white/blue				
22	23	24	25						
brown/blue	white/red	brown/red	white/black						

Multipole plug, series CON-MP

- open cable ends 25-pin
- with cable
- UL (Underwriters Laboratories)
- unshielded



Ambient temperature min./max.	-5 ... 50 °C
Operational voltage	24 V DC
Protection class	IP65
Wire cross-section	0.34 mm ²
Weight	See table below

Technical data

Part No.	Electrical connection	Max. current	Number of wires	Cable sheath
	1			
R412011244	Socket D-Sub 25-pin straight 180°	3 A	25	Polyvinyl chloride
R412011245	Socket D-Sub 25-pin straight 180°	3 A	25	Polyvinyl chloride
R412011246	Socket D-Sub 25-pin straight 180°	3 A	25	Polyvinyl chloride
R412011252	Socket D-Sub 25-pin straight 180°	3 A	25	Polyurethane
R412011253	Socket D-Sub 25-pin straight 180°	3 A	25	Polyurethane
R412011254	Socket D-Sub 25-pin straight 180°	3 A	25	Polyurethane
R412011248	Socket D-Sub 25-pin angled 90°	3 A	25	Polyvinyl chloride
R412011249	Socket D-Sub 25-pin angled 90°	3 A	25	Polyvinyl chloride
R412011250	Socket D-Sub 25-pin angled 90°	3 A	25	Polyvinyl chloride
R412011256	Socket D-Sub 25-pin angled 90°	3 A	25	Polyurethane
R412011257	Socket D-Sub 25-pin angled 90°	3 A	25	Polyurethane
R412011258	Socket D-Sub 25-pin angled 90°	3 A	25	Polyurethane

Part No.	Cable-Ø	Cable length	Certification	Weight		Fig.
R412011244	11.2 mm	3 m	UL (Underwriters Laboratories)	0.67 kg	-	Fig. 1
R412011245	11.2 mm	5 m	UL (Underwriters Laboratories)	1.06 kg	-	Fig. 1
R412011246	11.2 mm	10 m	UL (Underwriters Laboratories)	2.035 kg	-	Fig. 1
R412011252	12 mm	3 m	UL (Underwriters Laboratories)	0.8 kg	1)	Fig. 1
R412011253	12 mm	5 m	UL (Underwriters Laboratories)	1.28 kg	1)	Fig. 1
R412011254	12 mm	10 m	UL (Underwriters Laboratories)	2.475 kg	1)	Fig. 1
R412011248	11.2 mm	3 m	UL (Underwriters Laboratories)	0.675 kg	-	Fig. 2
R412011249	11.2 mm	5 m	UL (Underwriters Laboratories)	1.065 kg	-	Fig. 2
R412011250	11.2 mm	10 m	UL (Underwriters Laboratories)	2.04 kg	-	Fig. 2
R412011256	12 mm	3 m	UL (Underwriters Laboratories)	0.805 kg	1)	Fig. 2
R412011257	12 mm	5 m	UL (Underwriters Laboratories)	1.285 kg	1)	Fig. 2

Part No.	Cable-Ø	Cable length	Certification	Weight		Fig.
R412011258	12 mm	10 m	UL (Underwriters Laboratories)	2.48 kg	1)	Fig. 2

1) suitable for dynamic laying

Technical information

The specified protection class is only valid in assembled and tested state.
 Note for use with VS LP04: The plug can only be used in the LP04 versions with a side electrical connection.

Technical information

Material	
Housing	Polyamide
Cable sheath	Polyvinyl chloride Polyurethane

Dimensions

Fig. 1

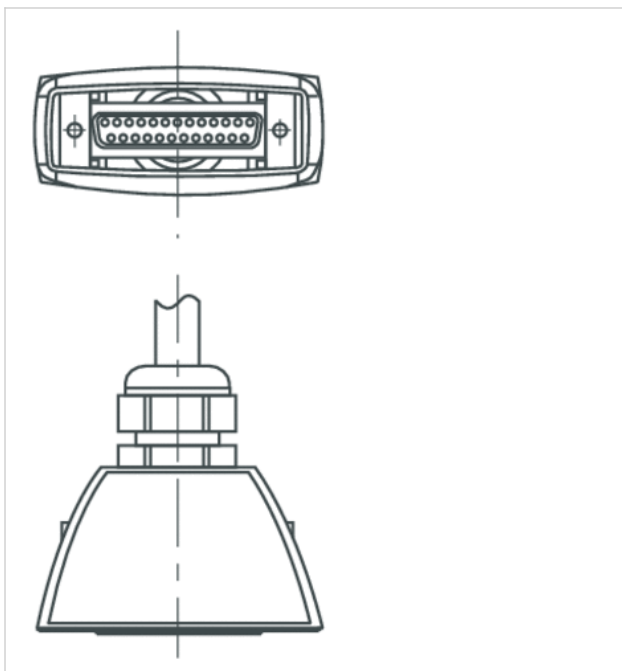
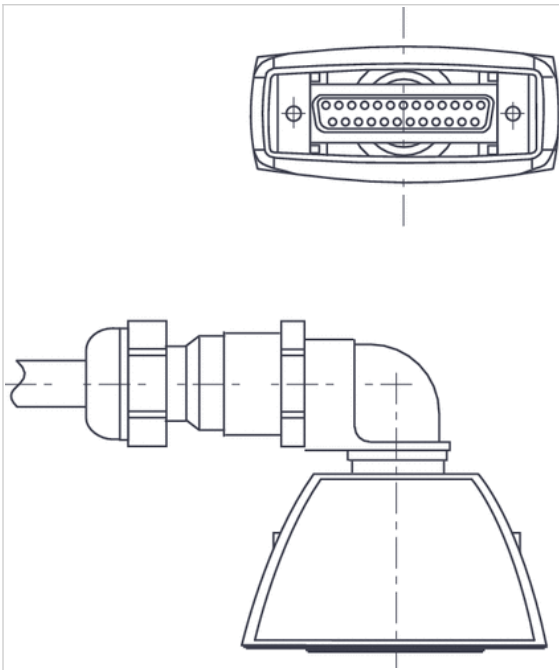
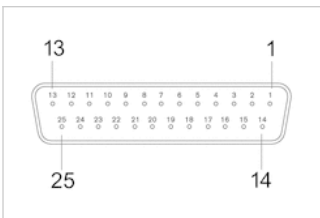

Fig. 2



Pin assignments

PIN assignment and cable colors, cable identification as per DIN 47100



Socket

Pin	1	2	3	4	5	6	7	8	9
Color	white	brown	green	yellow	gray	pink	blue	red	black
10	11	12	13	14	15				
violet	gray/pink	red/blue	white/green	brown/green	white/yellow				
16	17	18	19	20	21				
yellow/brown	white/gray	gray/brown	white/pink	pink/brown	white/blue				
22	23	24	25						
brown/blue	white/red	brown/red	white/black						

Multipole plug, series CON-MP

- Plug D-Sub 25-pin angled 90°
- Socket D-Sub 25-pin straight 180°
- with cable
- UL (Underwriters Laboratories)
- unshielded



Ambient temperature min./max.	-20 ... 80 °C
Operational voltage	24 V DC
Protection class	IP67
Wire cross-section	0.2 mm ²
Weight	See table below

Technical data

Part No.	Max. current	Number of wires	Cable-Ø	Cable length	Certification	Weight
R412020635	3 A	25	8.5 mm	0.5 m	UL (Underwriters Laboratories)	0.205 kg
R412020636	3 A	25	8.5 mm	1 m	UL (Underwriters Laboratories)	0.275 kg
R412020637	3 A	25	8.5 mm	2 m	UL (Underwriters Laboratories)	0.396 kg
R412020638	3 A	25	8.5 mm	5 m	UL (Underwriters Laboratories)	0.756 kg
R412020639	3 A	25	8.5 mm	10 m	UL (Underwriters Laboratories)	1.409 kg

Technical information

The specified protection class is only valid in assembled and tested state.

Technical information

Material	
Housing	Thermoplastic elastomer
Cable sheath	Polyvinyl chloride

Dimensions

Dimensions

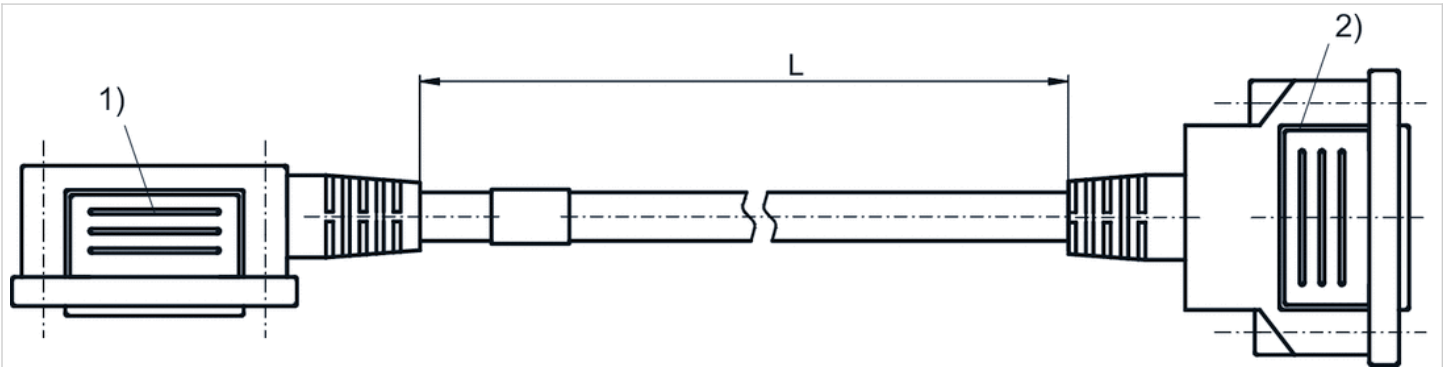

- 1) Port 1 (Plug)
- 2) Port 2 (Socket)

Pin assignments

PIN assignment and cable colors, cable identification as per DIN 47100

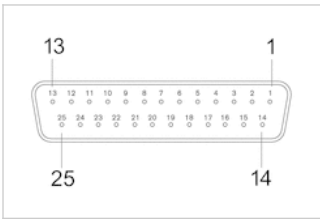

Socket

Pin	1	2	3	4	5	6	7	8	9
Color	white	brown	green	yellow	gray	pink	blue	red	black
10	11	12	13	14	15				
violet	gray/pink	red/blue	white/green	brown/green	white/yellow				
16	17	18	19	20	21				
yellow/brown	white/gray	gray/brown	white/pink	pink/brown	white/blue				
22	23	24	25						
brown/blue	white/red	brown/red	white/black						

Pin assignments

PIN assignment and cable colors, cable identification as per DIN 47100

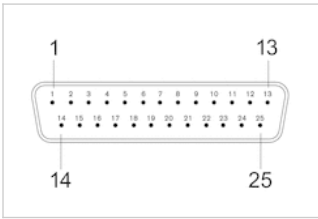

Plug

Pin	1	2	3	4	5	6	7	8	9
Color	white	brown	green	yellow	gray	pink	blue	red	black
10	11	12	13	14	15				
violet	gray/pink	red/blue	white/green	brown/green	white/yellow				
16	17	18	19	20	21				
yellow/brown	white/gray	gray/brown	white/pink	pink/brown	white/blue				
22	23	24	25						
brown/blue	white/red	brown/red	white/black						

Multipole plug, series CON-MP

- Plug D-Sub 25-pin angled 90°
- Socket D-Sub 25-pin angled 90°
- with cable
- UL (Underwriters Laboratories)
- unshielded



Ambient temperature min./max.	-20 ... 80 °C
Operational voltage	24 V DC
Protection class	IP67
Wire cross-section	0.2 mm ²
Weight	See table below

The delivered product may vary from that in the illustration.

Technical data

Part No.	Max. current	Number of wires	Cable-Ø	Cable length	Certification	Weight
R412020630	3 A	25	8.5 mm	0.5 m	UL (Underwriters Laboratories)	0.19 kg
R412020631	3 A	25	8.5 mm	1 m	UL (Underwriters Laboratories)	0.26 kg
R412020632	3 A	25	8.5 mm	2 m	UL (Underwriters Laboratories)	0.383 kg
R412020633	3 A	25	8.5 mm	5 m	UL (Underwriters Laboratories)	0.736 kg
R412020634	3 A	25	8.5 mm	10 m	UL (Underwriters Laboratories)	1.4 kg

Technical information

The specified protection class is only valid in assembled and tested state.

Technical information

Material	
Housing	Thermoplastic elastomer
Cable sheath	Polyvinyl chloride

Dimensions

Dimensions

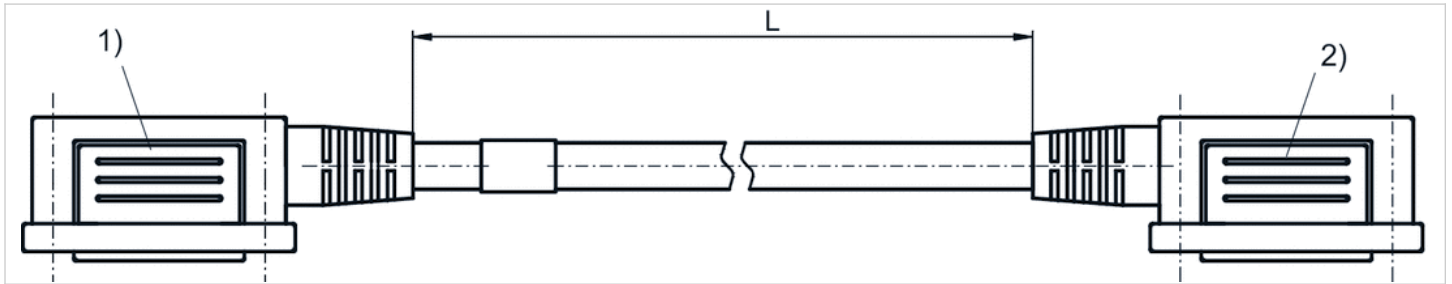

- 1) Port 1 (Plug)
- 2) Port 2 (Socket)

Pin assignments

PIN assignment and cable colors, cable identification as per DIN 47100

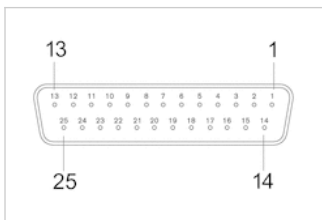

Socket

Pin	1	2	3	4	5	6	7	8	9
Color	white	brown	green	yellow	gray	pink	blue	red	black
10	11	12	13	14	15				
violet	gray/pink	red/blue	white/green	brown/green	white/yellow				
16	17	18	19	20	21				
yellow/brown	white/gray	gray/brown	white/pink	pink/brown	white/blue				
22	23	24	25						
brown/blue	white/red	brown/red	white/black						

Pin assignments

PIN assignment and cable colors, cable identification as per DIN 47100

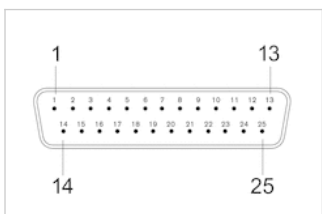

Plug

Pin	1	2	3	4	5	6	7	8	9
Color	white	brown	green	yellow	gray	pink	blue	red	black
10	11	12	13	14	15				
violet	gray/pink	red/blue	white/green	brown/green	white/yellow				
16	17	18	19	20	21				
yellow/brown	white/gray	gray/brown	white/pink	pink/brown	white/blue				
22	23	24	25						
brown/blue	white/red	brown/red	white/black						

Multipole plug, series CON-MP

- open cable ends 25-pin
- with cable
- unshielded



Ambient temperature min./max.	-20 ... 80 °C
Operational voltage	24 V DC
Protection class	IP67
Wire cross-section	0.22 mm ²
Weight	See table below

Technical data

Part No.	Electrical connection	Max. current	Number of wires	Cable sheath
	1			
R419500454	Socket D-Sub 25-pin straight 180°	3 A	25	Polyvinyl chloride
R419500455	Socket D-Sub 25-pin straight 180°	3 A	25	Polyvinyl chloride
R419500456	Socket D-Sub 25-pin straight 180°	3 A	25	Polyvinyl chloride
R412022156	Socket D-Sub 25-pin straight 180°	3 A	25	Polyvinyl chloride
R419500457	Socket D-Sub 25-pin straight 180°	3 A	25	Polyurethane
R419500458	Socket D-Sub 25-pin straight 180°	3 A	25	Polyurethane
R419500459	Socket D-Sub 25-pin straight 180°	3 A	25	Polyurethane
R419500460	Socket D-Sub 25-pin angled 90°	3 A	25	Polyvinyl chloride
R419500461	Socket D-Sub 25-pin angled 90°	3 A	25	Polyvinyl chloride
R419500462	Socket D-Sub 25-pin angled 90°	3 A	25	Polyvinyl chloride
R412022352	Socket D-Sub 25-pin angled 90°	3 A	25	Polyvinyl chloride
R419500463	Socket D-Sub 25-pin angled 90°	3 A	25	Polyurethane
R419500464	Socket D-Sub 25-pin angled 90°	3 A	25	Polyurethane
R419500465	Socket D-Sub 25-pin angled 90°	3 A	25	Polyurethane

Part No.	Bending radius min.	Cable-Ø	Cable length	Weight		Fig.
R419500454	-	8.5 mm	3 m	0.465 kg	-	Fig. 1
R419500455	-	8.5 mm	5 m	0.731 kg	-	Fig. 1
R419500456	-	8.5 mm	10 m	1.373 kg	-	Fig. 1
R412022156	-	8.5 mm	15 m	2.002 kg	-	Fig. 1
R419500457	78.75 mm	10.5 mm	3 m	0.51 kg	1)	Fig. 1
R419500458	78.75 mm	10.5 mm	5 m	0.789 kg	1)	Fig. 1
R419500459	78.75 mm	10.5 mm	10 m	1.491 kg	1)	Fig. 1
R419500460	-	8.5 mm	3 m	0.46 kg	-	Fig. 2
R419500461	-	8.5 mm	5 m	0.707 kg	-	Fig. 2
R419500462	-	8.5 mm	10 m	1.334 kg	-	Fig. 2
R412022352	-	8.5 mm	15 m	1.982 kg	-	Fig. 2

Part No.	Bending radius min.	Cable-Ø	Cable length	Weight		Fig.
R419500463	78.75 mm	10.5 mm	3 m	0.484 kg	1)	Fig. 2
R419500464	78.75 mm	10.5 mm	5 m	0.767 kg	1)	Fig. 2
R419500465	78.75 mm	10.5 mm	10 m	1.461 kg	1)	Fig. 2

1) suitable for dynamic laying

Technical information

The specified protection class is only valid in assembled and tested state.
The increased wire cross-section of pin 25 is 0.82 mm².

Technical information

Material

Housing	Thermoplastic elastomer
Cable sheath	Polyvinyl chloride Polyurethane

Dimensions

Fig. 1

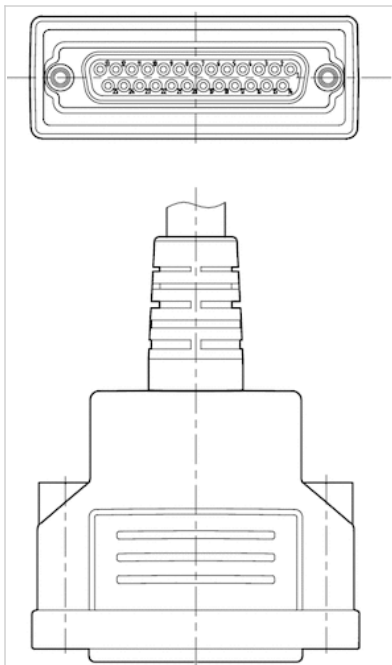
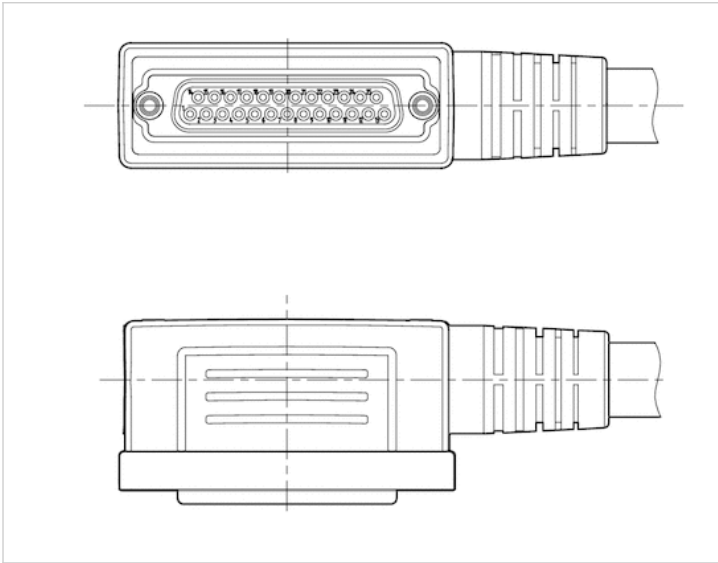
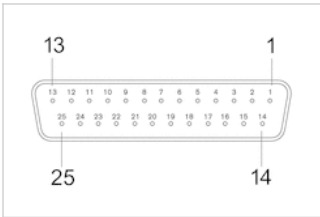

Fig. 2



Pin assignments

PIN assignment and cable colors, cable identification as per DIN 47100



Socket

Pin	1	2	3	4	5	6	7	8	9
Color	white	brown	green	yellow	gray	pink	blue	red	black
10	11	12	13	14	15				
violet	gray/pink	red/blue	white/green	brown/green	white/yellow				
16	17	18	19	20	21				
yellow/brown	white/gray	gray/brown	white/pink	pink/brown	white/blue				
22	23	24	25						
brown/blue	white/red	brown/red	white/black						

Multipole plug, series CON-MP

- Socket D-Sub 37-pin straight 180°
- open cable ends
- with cable
- unshielded



Ambient temperature min./max.	See table below
Operational voltage	24 V DC
Protection class	IP65
Wire cross-section	0.25 mm ²
Weight	See table below

Technical data

Part No.	Ambient temperature min./max.	Max. current	Number of wires	Cable length	Weight
R422101476	-15 ... 50 °C	3 A	37	3 m	0.73 kg
R422101478	-40 ... 50 °C	3 A	37	10 m	2.28 kg

Technical information

The specified protection class is only valid in assembled and tested state.

Technical information

Material	
Cable sheath	Polyvinyl chloride

Dimensions

Dimensions

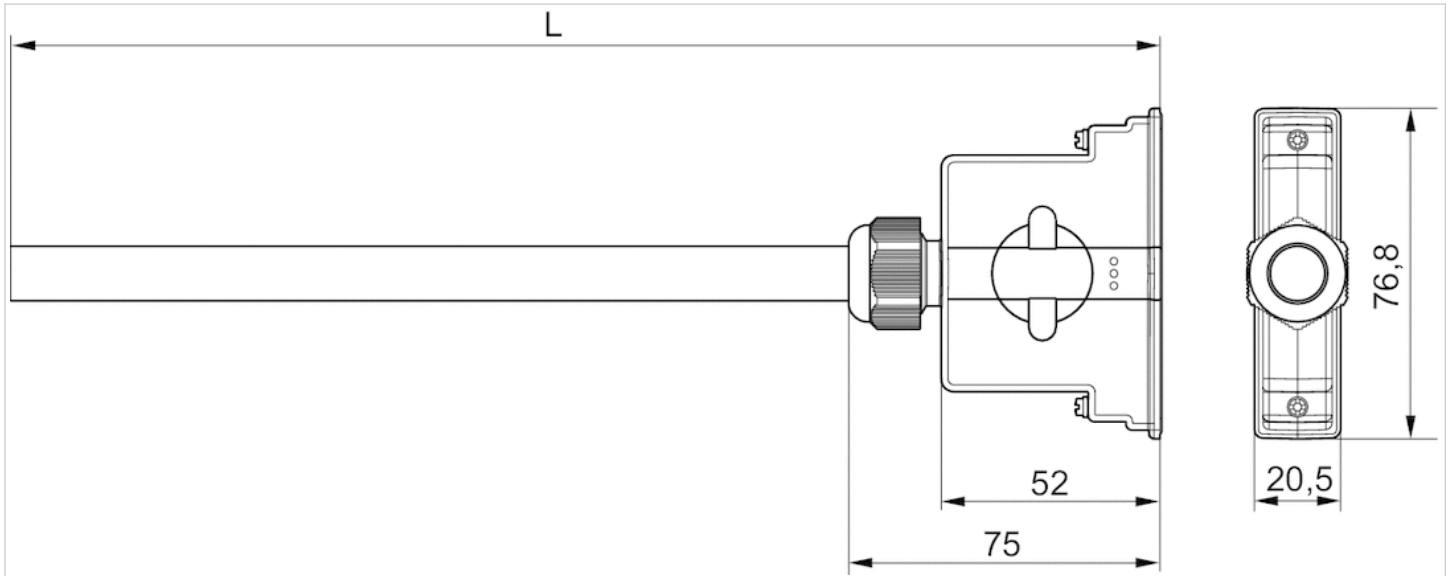

Pin assignments

PIN assignment and cable colors

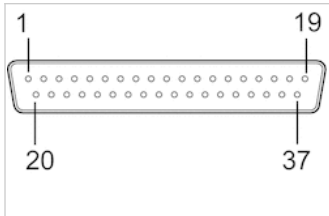

Pin	1	2	3	4	5	6	7	8	9
Color	white	brown	green	yellow	gray	pink	blue	red	black
10	11	12	13	14	15				
violet	gray/pink	red/blue	white/green	brown/green	white/yellow				
16	17	18	19	20	21				
yellow/brown	white/gray	gray/brown	white/pink	pink/brown	white/blue				
22	23	24	25	26	27				
brown/blue	white/red	brown/red	white/black	brown/black	gray/green				
28	29	30	31	32	33				
yellow/gray	pink/green	yellow/pink	green/blue	yellow/blue	green/red				
34	35	36	37						
yellow/red	gray/black	yellow/black	gray/blue						

Multipole plug, series CON-MP

- open cable ends 36-pin
- with cable
- unshielded



Ambient temperature min./max.	-5 ... 50 °C
Operational voltage	24 V DC
Protection class	IP65
Wire cross-section	0.25 mm ²
Weight	See table below

Technical data

Part No.	Electrical connection	Max. current	Number of wires	Cable sheath
	1			
R412011262	Socket D-Sub 44-pin straight 180°	3 A	36	Polyvinyl chloride
R412011263	Socket D-Sub 44-pin straight 180°	3 A	36	Polyvinyl chloride
R412011264	Socket D-Sub 44-pin straight 180°	3 A	36	Polyvinyl chloride
R412011271	Socket D-Sub 44-pin straight 180°	3 A	36	Polyurethane
R412011272	Socket D-Sub 44-pin straight 180°	3 A	36	Polyurethane
R412011267	Socket D-Sub 44-pin angled 90°	3 A	36	Polyvinyl chloride
R412011268	Socket D-Sub 44-pin angled 90°	3 A	36	Polyvinyl chloride
R412011276	Socket D-Sub 44-pin angled 90°	3 A	36	Polyurethane

Part No.	Bending radius min.	Cable-Ø	Cable length	Weight	
R412011262	-	11.1 mm	3 m	0.635 kg	-
R412011263	-	11.1 mm	5 m	1.005 kg	-
R412011264	-	11.1 mm	10 m	1.93 kg	-
R412011271	120 mm	12 mm	5 m	1.3 kg	1)
R412011272	120 mm	12 mm	10 m	2.52 kg	1)
R412011267	-	11.1 mm	5 m	1.01 kg	-
R412011268	-	11.1 mm	10 m	1.935 kg	-
R412011276	120 mm	12 mm	10 m	2.525 kg	1)

1) suitable for dynamic laying

Technical information

The specified protection class is only valid in assembled and tested state.

Note for use with VS LP04: The plug can only be used in the LP04 versions with a side electrical connection.

The 44-pin multipole plugs are pre-assembled with a 36-pin cable.

Technical information

Material

Housing	Polyamide
Cable sheath	Polyvinyl chloride Polyurethane

Dimensions

Dimensions

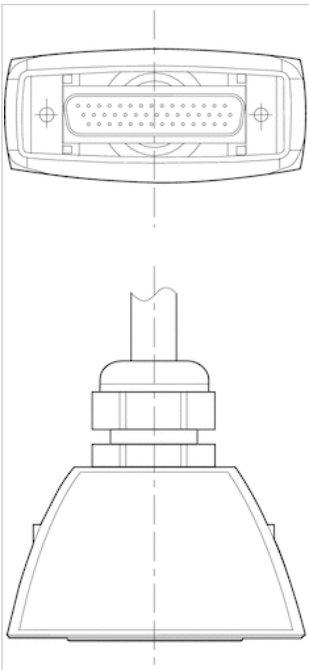

Pin assignments

PIN assignment and cable colors, cable identification as per DIN 47100

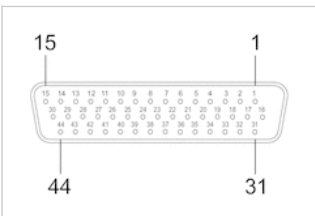

Socket

Pin	1	2	3	4	5	6	7	8	9
Color	white	brown	green	yellow	gray	pink	blue	red	black
10	11	12	13	14	15				
violet	gray/pink	red/blue	white/green	brown/green	white/yellow				
16	17	18	19	20	21				
yellow/brown	white/gray	gray/brown	white/pink	pink/brown	white/blue				
22	23	24	25	26	27				
brown/blue	white/red	brown/red	white/black	brown/black	gray/green				
28	29	30	31	32	33				
yellow/gray	pink/green	yellow/pink	green/blue	yellow/blue	green/red				
34	35	36	37	38	39	40			
yellow/red	gray/black	yellow/black	gray/blue	pink/blue	gray/red	pink/red			
41	42	43	44						
gray/black	pink/black	blue/black	red/black						

Multipole plug, series CON-MP

- open cable ends 44-pin
- with cable
- unshielded



Ambient temperature min./max.	See table below
Operational voltage	24 V DC
Protection class	IP65
Wire cross-section	0.22 mm ²
Weight	See table below

Technical data

Part No.	Ambient temperature min./max.	Electrical connection	Max. current	Number of wires
		1		
R419500466	-20 ... 80 °C	Socket D-Sub 44-pin straight 180°	3 A	44
R419500467	-20 ... 80 °C	Socket D-Sub 44-pin straight 180°	3 A	44
R419500468	-20 ... 80 °C	Socket D-Sub 44-pin straight 180°	3 A	44
R419500469	-20 ... 80 °C	Socket D-Sub 44-pin straight 180°	3 A	44
R419500470	-20 ... 80 °C	Socket D-Sub 44-pin straight 180°	3 A	44
R419500471	-20 ... 80 °C	Socket D-Sub 44-pin straight 180°	3 A	44
R419500472	-20 ... 80 °C	Socket D-Sub 44-pin angled 90°	3 A	44
R419500473	-20 ... 80 °C	Socket D-Sub 44-pin angled 90°	3 A	44
R419500474	-20 ... 80 °C	Socket D-Sub 44-pin angled 90°	3 A	44
R419500475	-20 ... 80 °C	Socket D-Sub 44-pin angled 90°	3 A	44
R419500476	-20 ... 80 °C	Socket D-Sub 44-pin angled 90°	3 A	44
R419500477	-25 ... 80 °C	Socket D-Sub 44-pin angled 90°	3 A	44

Part No.	Cable sheath	Bending radius min.	Cable-Ø	Cable length	Weight		Fig.
R419500466	Polyvinyl chloride	-	10.7 mm	3 m	0.632 kg	-	Fig. 1
R419500467	Polyvinyl chloride	-	10.7 mm	5 m	1.013 kg	-	Fig. 1
R419500468	Polyvinyl chloride	-	10.7 mm	10 m	1.934 kg	-	Fig. 1
R419500469	Polyurethane	97.5 mm	13 mm	3 m	0.722 kg	1)	Fig. 1
R419500470	Polyurethane	97.5 mm	13 mm	5 m	1.146 kg	1)	Fig. 1
R419500471	Polyurethane	97.5 mm	13 mm	10 m	2.288 kg	1)	Fig. 1
R419500472	Polyvinyl chloride	-	10.7 mm	3 m	0.61 kg	-	Fig. 2
R419500473	Polyvinyl chloride	-	10.7 mm	5 m	1.001 kg	-	Fig. 2
R419500474	Polyvinyl chloride	-	10.7 mm	10 m	1.913 kg	-	Fig. 2
R419500475	Polyurethane	97.5 mm	13 mm	3 m	0.747 kg	1)	Fig. 2
R419500476	Polyurethane	97.5 mm	13 mm	5 m	1.178 kg	1)	Fig. 2
R419500477	Polyurethane	97.5 mm	13 mm	10 m	2.295 kg	1)	Fig. 2

1) suitable for dynamic laying

Technical information

The specified protection class is only valid in assembled and tested state.

Technical information

Material	
Housing	Thermoplastic elastomer
Cable sheath	Polyvinyl chloride Polyurethane

Dimensions

Fig. 1

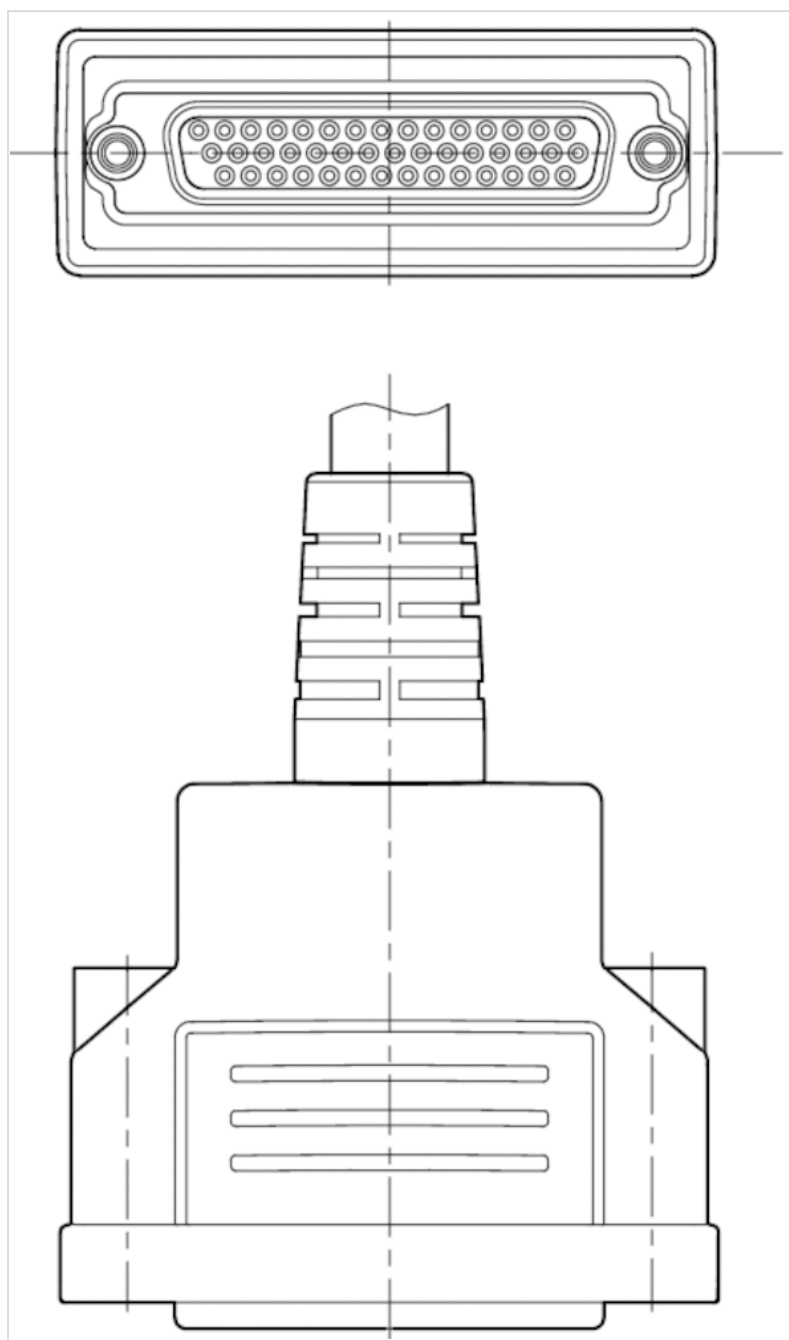
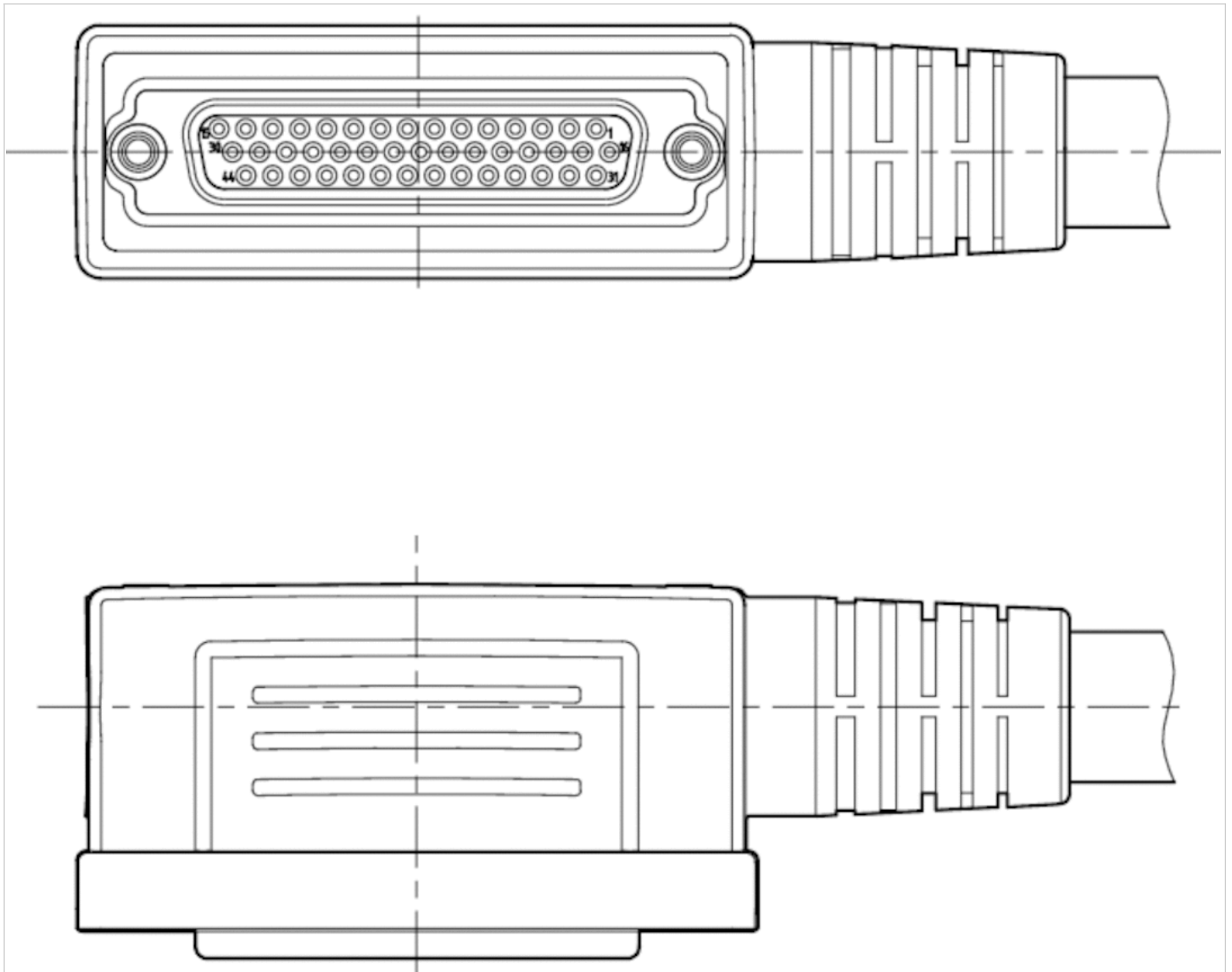
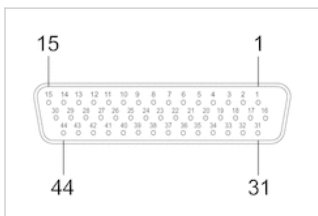

Fig. 2



Pin assignments

PIN assignment and cable colors, cable identification as per DIN 47100



Socket

Pin	1	2	3	4	5	6	7	8	9
Color	white	brown	green	yellow	gray	pink	blue	red	black
10	11	12	13	14	15				
violet	gray/pink	red/blue	white/green	brown/green	white/yellow				
16	17	18	19	20	21				
yellow/brown	white/gray	gray/brown	white/pink	pink/brown	white/blue				
22	23	24	25	26	27				
brown/blue	white/red	brown/red	white/black	brown/black	gray/green				
28	29	30	31	32	33				
yellow/gray	pink/green	yellow/pink	green/blue	yellow/blue	green/red				
34	35	36	37	38	39	40			
yellow/red	gray/black	yellow/black	gray/blue	pink/blue	gray/red	pink/red			
41	42	43	44						
gray/black	pink/black	blue/black	red/black						

Efficient pneumatic solutions, our program: cylinders and drives, valves and valve systems, air supply management



Visit us: Emerson.com/Aventics

Your local contact: Emerson.com/contactus



Emerson.com



Facebook.com/EmersonAutomationSolutions



LinkedIn.com/company/Emerson-Automation-Solutions



Twitter.com/EMR_Automation

An example configuration is depicted on the title page. The delivered product may thus vary from that in the illustration. Subject to change. This Document, as well as the data, specifications and other information set forth in it, are the exclusive property of AVENTICS GmbH. It may not be reproduced or given to third parties without its consent. Only use the AVENTICS products shown in industrial applications. Read the product documentation completely and carefully before using the product. Observe the applicable regulations and laws of the respective country. When integrating the product into applications, note the system manufacturer's specifications for safe use of the product. The data specified only serve to describe the product. No statements concerning a certain condition or suitability for a certain application can be derived from our information. The information given does not release the user from the obligation of own judgment and verification. It must be remembered that the products are subject to a natural process of wear and aging.

The Emerson logo is a trademark and service mark of Emerson Electric Co. Brand logotype are registered trademarks of one of the Emerson family of companies. All other marks are the property of their respective owners. © 2017 Emerson Electric Co. All rights reserved.
2019-03



CONSIDER IT SOLVED™



青岛秉诚自动化设备有限公司
地址：中国·青岛市重庆南路99号海尔云街甲3号楼7F

服务热线：4006-918-365
网址：<http://www.ivalve.cc>

传真：(86-532)585-10-365
Email：sales@bechinas.com