

ASCO™ MINIATURE SOLENOID VALVES

ROCKER MECHANISM, FLUID ISOLATION VALVES

SERIES
062

- Rocker isolation valves are designed for use with neutral or highly aggressive liquids in analytical instruments
- Special rocker mechanism, combined with a separating diaphragm, prevents heat transfer to the fluid and eliminates the sticking effect of the valve seat
- Excellent self-draining capability and easy-to-flush low-volume internal cavity make these valves ideal in applications where cross-contamination must be minimized
- Removable and rotatable electrical coils allow for easy installation and worry-free maintenance
- Meets all relevant CE directives, and is RoHS compliant
- Typical applications include:
 - In-Vitro Diagnostics
 - Hematology
 - DNA Sequencing
 - Industrial Liquid Analyzers

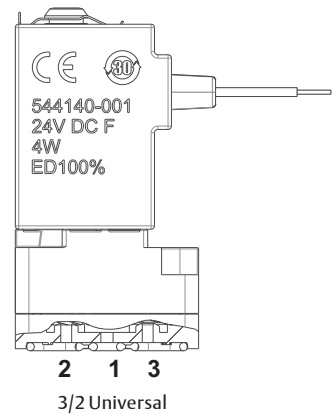
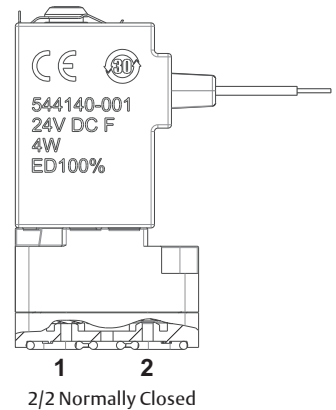
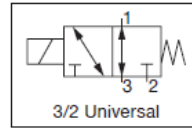
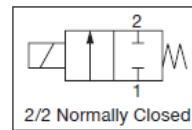

Fluids *	Temperature Range	Seal Materials *
Liquids or Gases	-10°C to +50°C (14°F to 122°F)	EPDM (ethylene-propylene) FKM

* Ensure that the compatibility of the materials in contact with the fluids is verified.

General Valve Information	
Body	PPS
Seals	EPDM, FKM
Response Time	< 20 ms
Ambient Temperature Range	-10°C to +60°C (14°F to 140°F)
Internal Volume	67 µl

Electrical Characteristics	
Coil Insulation Class	F (155°C [311°F])
Duty Cycle	100%
Connector	Lead Wires, L=500mm (19.7in)
Connector Specification	24 AWG
Electrical Safety	IEC 335
Electrical Enclosure Protection	IP65 (EN 60529)
Standard Voltages	12 VDC - 24V DC (-5% / +10%)

01102GB-2021/R01
Availability, design and specifications are subject to change without notice. All rights reserved.

Specifications								
Connection	Orifice Size	Flow Coefficient		Operating Pressure bar (psi)			Power Rating W	Catalog Number
				Min.	Max.			
	mm (in)	Kv (m ³ /h)	Cv			gases	liquids	
2/2 NC - Normally closed								
Pad mount	1.6 (0.063)	0.03	0.035	-0.53 (-7.69)	2.0 (29)	2.0 (29)	4.0	R062A210L0X00FX
Barb fitting	1.6 (0.063)	0.03	0.035	-0.53 (-7.69)	2.0 (29)	2.0 (29)	4.0	6062A210L0X00FX
3/2 U - Universal								
Pad mount	1.6 (0.063)	0.03	0.035	-0.53 (-7.69)	2.0 (29)	2.0 (29)	4.0	R062A310L0X00FX
Barb fitting	1.6 (0.063)	0.03	0.035	-0.53 (-7.69)	2.0 (29)	2.0 (29)	4.0	6062A310L0X00FX

How to Order

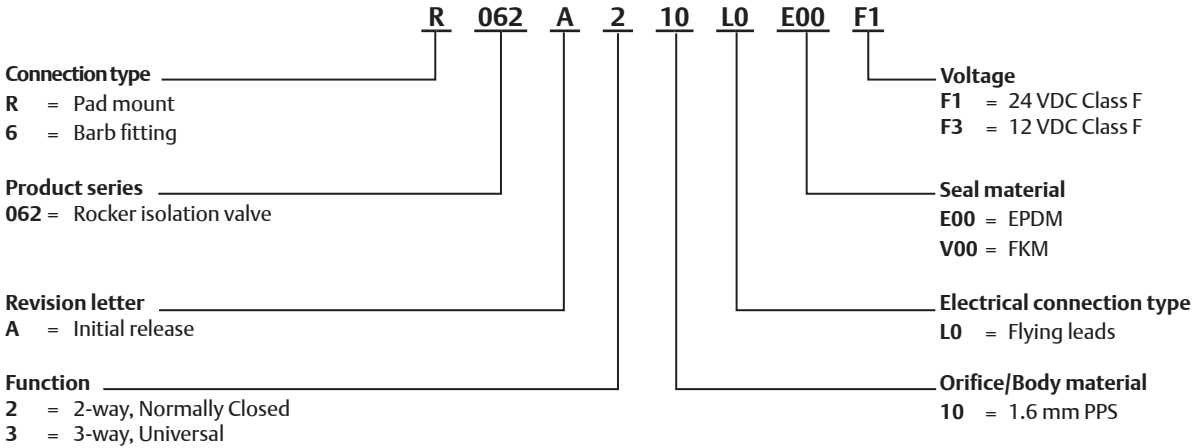

Installation

- The solenoid valves can be mounted in any position without affecting operation
- Hose barb connection of flexible soft tubing Ø 1.6mm to 2mm ID

ASCO™ MINIATURE SOLENOID VALVES

ROCKER MECHANISM, FLUID ISOLATION VALVES

Dimensions: mm (inches)

2-way and 3-way Pad Mount

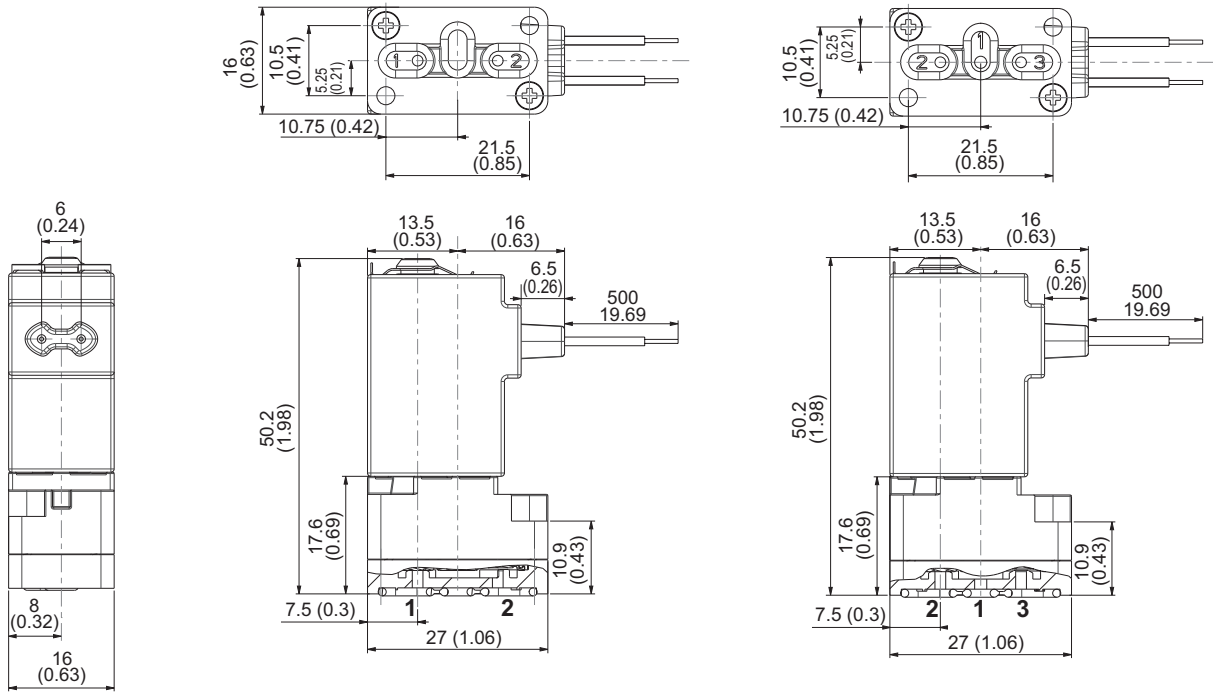

Subbase interface dimensions

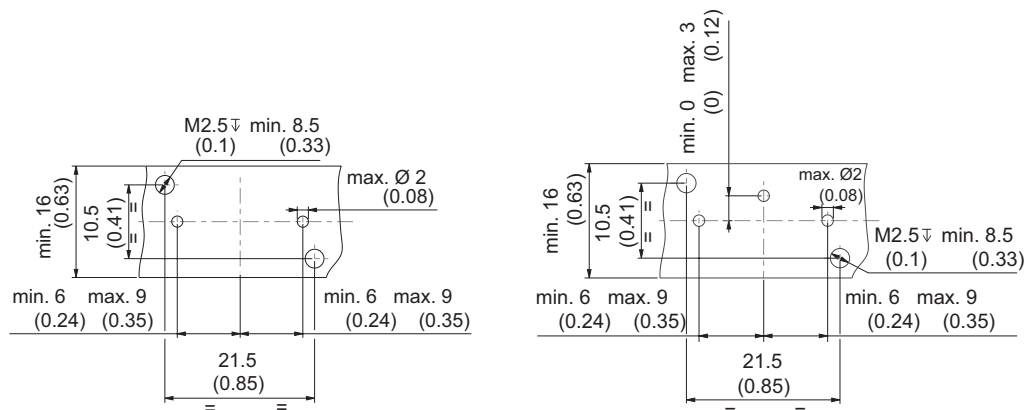

01102GB-2021/R01
Availability, design and specifications are subject to change without notice. All rights reserved.

Dimensions: mm (inches)

2-way and 3-way Barb Fitting

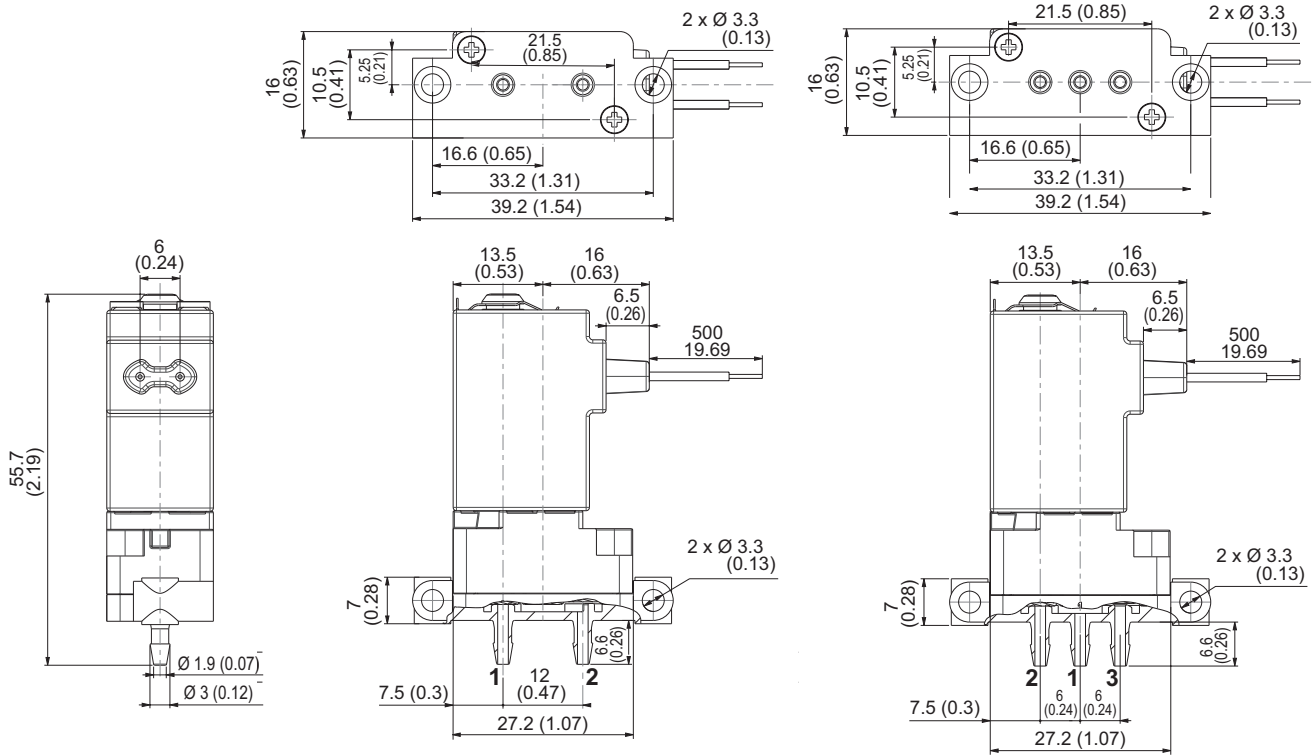

01102GB-2021/R01
Availability, design and specifications are subject to change without notice. All rights reserved.