

ASCO™ MINIATURE SOLENOID VALVES

PINCH VALVES, COMPACT 3-WAY SOLENOID

- The 384 Series is a 3-Way universal solenoid-operated pinch valve designed for use with highly aggressive or high-purity liquids in analytical and medical instrumentation, and industrial applications
- Hermetic separation of control mechanism and the fluid within the tubing prevents particulate contamination caused by friction of moving parts, assuring maximum purity of liquids
- Available in a large range of body sizes to accommodate a wide variety of tubing sizes
- Removable and rotatable electrical coils allow for easy installation and worry-free maintenance
- Bi-directional flow for exceptional versatility
- Meets all relevant CE directives, and is RoHS compliant
- Typical applications include:
 - Hemodialysis
 - Urinary Collection Systems,
 - Intravenous (IV) Systems
 - Drug Dispensing

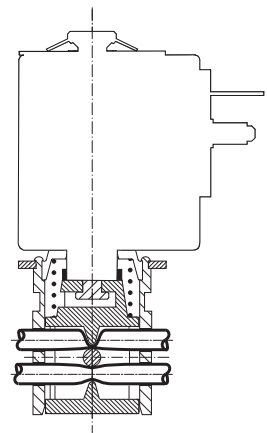
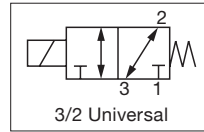

Fluids*	Temperature Range
Air, Inert Gases, Water, Oil or Liquids	0 °C to 50 °C (32 °F to 122 °F)

* Ensure that the compatibility of the materials in contact with the fluids is verified

General Valve Information*		
Body	Aluminum, anodized	POM (Graphite-reinforced polyacetal)
Pinch Mechanism	POM (Graphite-reinforced polyacetal)	
Others	Stainless Steel	
Guide Tube	Nickel-plated Brass	
Coil frame	Galvanized steel	
Recommended Tubing	VMQ (silicone) (max. hardness: 50 Shore A) (Tubing not supplied with valve)	VMQ (silicone) (max. Hardness: 50 Shore A) 30cm (12in) tubing supplied with valve

Electrical Characteristics		
	Aluminium body	POM body
Coil Insulation Class	F	F
Connector	Spade plug; cable Ø4-6mm (0.16-0.24in), Ø6-10mm (0.24-0.40in)	
Connector Specification	4 W/8 W/6 W (DMX); DIN 43650, 9.4 mm, industry standard B; 6 W/13 W (AMX/FNX); ISO 4400/EN 175301-803, form A	305mm (12in) Lead Wires
Electrical Safety	IEC 335	IEC 335
Electrical Enclosure Protection	Coil type 01 = IP65 / Coil type 02-03 = IP65	IP30 (EN 60529)
Standard Voltages ¹	12 VDC, 24 VDC	12 VDC, 24 VDC
Power Consumption	4W, 6W, 8W, 9W, 13W	3.5W
Response Time	< 20ms	< 10ms

¹ Other voltages on request

Prefix Option	Power Ratings				Ambient Temperature Ranges °C (°F)	Replacement Coil		Type ²
	Inrush VA	Holding VA	Hot/Cold W			12 VDC	24 VDC	
			W	W				
SC	-	-	4	-10 to 60 (14 to 140)	43005268	43005269	01 (DNX-4)	
			8		500701-001	500701-002		
			6		500701-003	500701-004		
			9		43005143	43005144		
			13		43005316	43005317		02 (AMX) 03 (FNX)

² Refer to the dimensional drawings on the following page

USE IN INTERMITTENT SERVICE
Minimum waiting time between each application of power

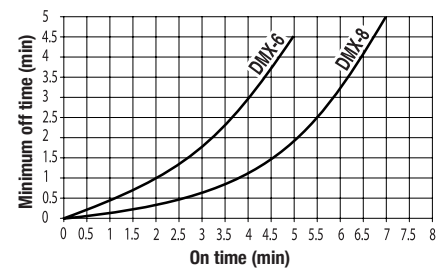

01086GB-2019-R01

Specifications										
Tube I.D.	Tube O.D.	Pinch Force	Operating Pressure bar (psi)			Power Rating		Catalog Number		
			min.	max.						
mm (inches)	mm (inches)	daN			inert gases	liquids	W	Aluminium body	POM body	
									24 VDC	12 VDC
0.76 (0.030)	1.65 (0.065)	0.12	0	0.8 (11.6)	0.8 (11.6)	-	4	SCH384B004	-	-
1.02 (0.040)	2.16 (0.085)	0.18	0	0.8 (11.6)	0.8 (11.6)	-	4	SCH384B001	-	-
1.57 (0.062)	3.18 (0.125)	0.22	0	0.8 (11.6)	0.8 (11.6)	-	8	SCH384B0023	-	-
1.98 (0.078)	3.18 (0.125)	0.18	0	0.8 (11.6)	0.8 (11.6)	-	6	SCH384B0033	-	-
3.4 (0.132)	4.7 (0.183)	0.4	0	0.8 (11.6)	0.8 (11.6)	-	9	SCH384A005	-	-
4.8 (0.187)	7.9 (0.313)	0.85	0	0.8 (11.6)	0.8 (11.6)	-	13	SCH384B006	-	-
6.4 (0.250)	9.5 (0.375)	1.1	0	0.8 (11.6)	0.8 (11.6)	-	13	SCH384B007	-	-
1.6 (0.063)	3.2 (0.126)	0.22	0	1.5 (21.8)	1.5 (21.8)	-	3.5	-	P384A024LCA00V1	P384A024LCA00V3
1.6 (0.063)	3.2 (0.126)	0.22	0	1.5 (21.8)	1.5 (21.8)	-	3.5	-	P384A025LCA00V14	P384A025LCA00V34

³ Observe the minimum of time stated, see graph above

⁴ The flange is rotatable with 90° (please see "Pic. 2" on following page)

How to Order

Aluminum body

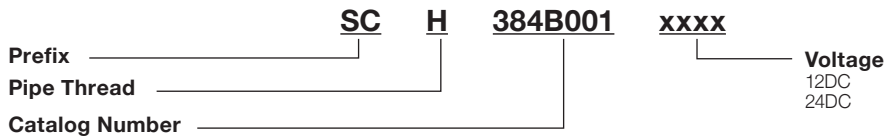

How to Order

POM Body

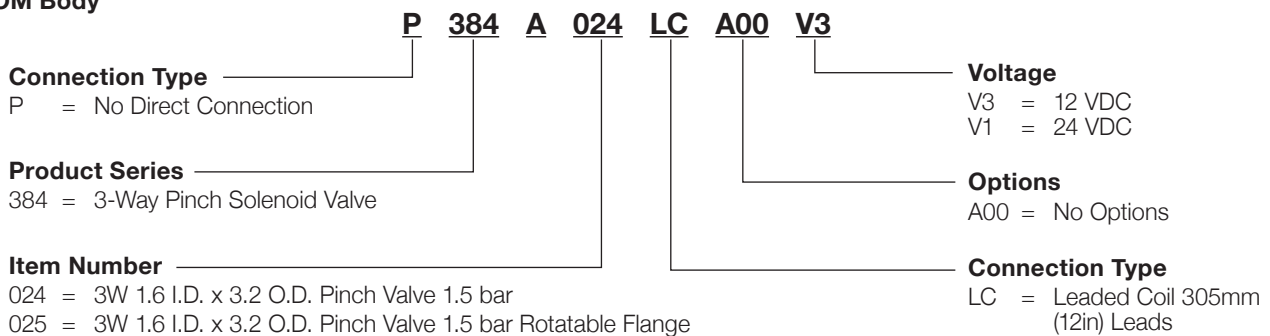

ASCO™ MINIATURE SOLENOID VALVES

PINCH VALVES, COMPACT 3-WAY SOLENOID

Dimensions (Aluminium body): mm (inches)

Type 01

Prefix "SC" solenoid
IEC 335/DIN 43650
IP65



Type 01: SCH384B001/0002/003/004

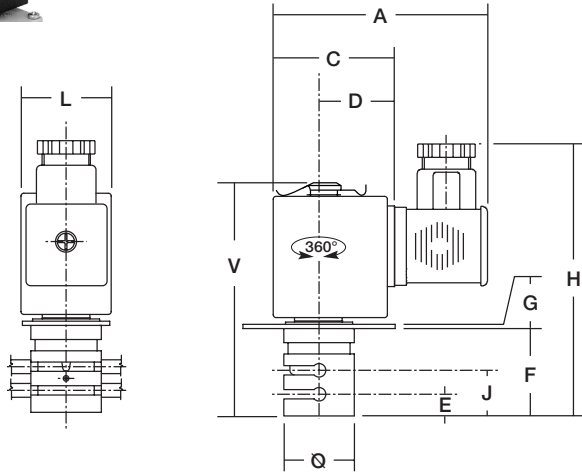

① Impulse Manual Operator

Bottom View

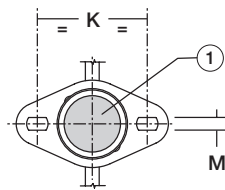

Type 02-03

Prefix "SC" solenoid
IEC 335/ISO 4400
IP65



Type 02: SCH384A005
Type 03: SCH384B006/B007

Tube Guiding Device

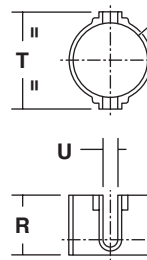

Arrangement for Wall-Fitting

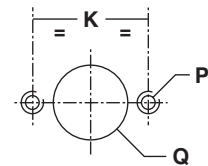

Example of Banked Assembly

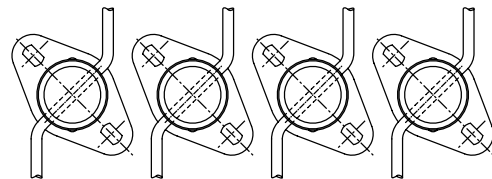

Type	Prefix Option	Catalog Number	Ø	A	C	D	E	F	G	H	K	L	M	P	Q	R	S	T	U	V	Tube Guiding Device		
																					Catalog Number	Weight ¹ kg	
01	SC	SCH384B001/002/003/004	16 (0.63)	49.5 (1.95)	23.5 (0.92)	15 (0.59)	11 (0.24)	20 (0.79)	1 (0.04)	66 (2.60)	24 (0.43)	17 (0.67)	3.3 (0.13)	M3	16.5 (0.65)	10.7 (0.42)	16 (0.63)	24 (0.94)	2.2 (0.09)	51.2 (2.02)	0.06	C140094	0.005
02	SC	SCH384A005	25 (0.98)	78 (3.07)	43 (1.69)	27 (1.06)	17.5 (0.41)	32 (1.26)	1.5 (0.06)	99 (3.90)	39 (1.54)	32 (1.26)	3.3 (0.18)	M4	25.5 (1.00)	14 (0.55)	25 (0.98)	33 (1.30)	3.2 (0.12)	82.5 (3.25)	0.30	C140095	0.009
03	SC	SCH384B006/B007	30 (1.18)	84 (3.31)	49 (1.93)	28 (1.10)	24.5 (0.96)	43.5 (1.71)	1.5 (0.06)	99 (3.90)	45.5 (1.79)	42 (1.65)	4.5 (0.18)	M4	30.5 (1.20)	24 (0.94)	30 (1.18)	39 (1.54)	6 (0.24)	99 (3.90)	0.45	C140096	0.015

¹ Including coil(s) and connectors

Options (Aluminium body)

- Flexible tubes having to use an external guiding device for optimum support (see dimensions):
 - With an outside diameter lower than 2.2mm (0.087in) (catalog numbers **SCH384B001** to **..B004**)
 - With an outside diameter lower than 3.5mm (0.138in) (catalog number **SCH384A005**)
 - With an outside diameter lower than 6mm (0.240in) (catalog numbers **SCH384B006** and **..007**)
 - Contact us for information regarding the usage of different tubing other than those recommended
- Plug with visual indication and peak voltage suppression or with cable length of 2m (78.7in)

Installation (Aluminium body)

- The solenoid valves can be mounted in any position without affecting operation, however, for optimum performance it is recommended that they be fitted with the solenoid operator at the top
- Fixing plate built in between the body and the coil for assembly in a bank on a base plate
- Flexible tubes are not included in our supply
- In case the tubing is not placed in its seat, the solenoid valve could operate incorrectly.

01086GB-2019-R01

Dimensions (POM body): mm (inches)

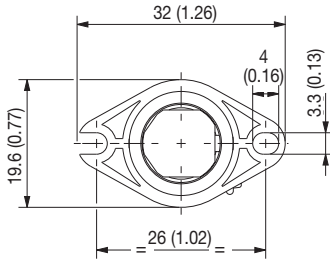

Pic. 1

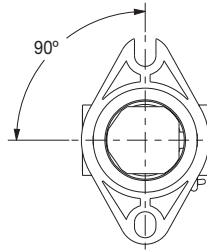

Pic. 2

Tube Guiding Device

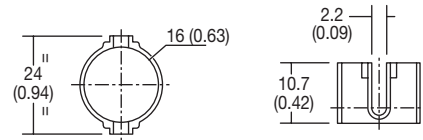

Arrangement for Wall-fitting

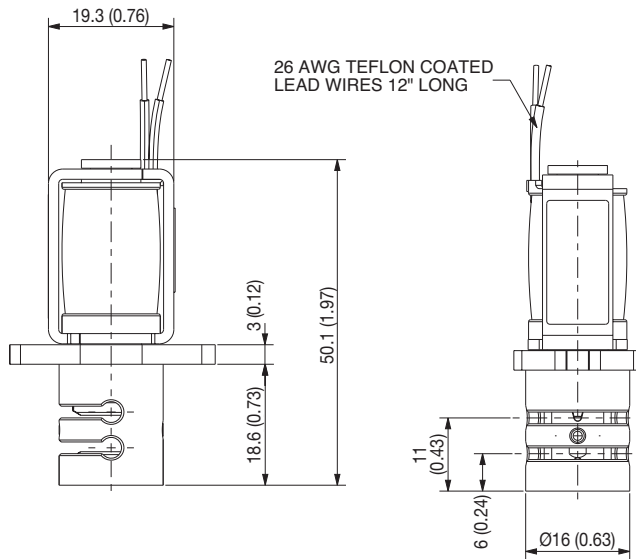
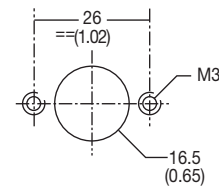

Catalog Number	Weight ¹	Tube Guiding Device	
	kg	Catalog Number	Weight ¹
P384A024LCA00V1/V3	0.04		
P384A025LCA00V1/V3		25978-01	0.005

¹ Including coil(s) and connectors

Options (POM body)

- Flexible tubes having to use an external guiding device for optimum support (see dimensions);
- With an outside diameter lower than 2.2mm (0.087in)
- Contact us for information regarding the usage of different tubing other than those recommended

Installation (POM body)

- The solenoid valves can be mounted in any position without affecting operation, however, for optimum performance it is recommended that they be fitted with the solenoid operator at the top
- Fixing plate built in between the body and the coil for assembly in a bank on a base plate
- In case the tubing is not placed in its seat, the solenoid valve could operate incorrectly.