















APPLICATIONS PROCESS INDUSTRY

Product Index



Function	ΔP		Temperature			Pipe connections	Series	Page	
	min. (bar)	max. (bar)	min. (°C)	max. (°C)					
BRASS BODY									
3/2 U	0	10	-50	+120	ATEX Ex d, IP66/67 IEC 61508		1/4 - 1/2	327	1
	0	10	-50	+120	IP65, IEC 61508		1/4 - 1/2	327	(1)
3/2 NC	0/2	10	-40	+60	Monostable/bistable, IP67, IEC 61508		1/4	551	(1)
5/2	0/2	10	-40	+60	Monostable/bistable, IP67, IEC 61508		1/4	551	(2)
3/2 NC - 5/2 NAMUR	0/2	10	-40	+60	Monostable/bistable, IP67, IEC 61508		1/4	551	(2)
STAINLESS STEEL BODY									
3/2 U	0	10	-50	+120	ATEX Ex d, IP66/67 IEC 61508		1/4 - 1/2	327	1
	0	10	-50	+120	IP65, IEC 61508		1/4 - 1/2	327	(1)
3/2 NC	0/2	10	-40	+80	Monostable/bistable, IP67, IEC 61508		1/4	551	3/2
5/2-5/3			-40	+60			1/2	553	5/2-5/3
3/2 NC - 5/2 NAMUR	2	10	-40	+80	Monostable/bistable, IP65, IEC 61508		1/4	551	3/2
			-40	+60			1/2	553	5/2-5/3
ALUMINIUM BODY									
3/2 NC	2	10	-25	+60	Monostable/bistable, IP67, IEC 61508		1/4 - 1/2	551-553	(1)
	0/2	10	-25	+60	Monostable/bistable, IP67, IEC 61508		1/4 - 1/2	551-553	
5/2 - 5/3	2	10	-25	+60	Monostable/bistable, IP67, IEC 61508		1/4 - 1/2	551-553	(2)
	0/2	10	-25	+60	Monostable/bistable, IP67, IEC 61508		1/4 - 1/2	551-553	
3/2 NC - 5/2 - 5/3 NAMUR	2	10	-25	+60	Monostable/bistable, IP67, IEC 61508		1/4 - 1/2	551-553	(2)
	0/2	10	-25	+60	Monostable/bistable, IP67, IEC 61508		1/4 - 1/2	551-553	
3/2 NC - 5/2 NAMUR	2	8	-20	+60	Monostable/bistable, IP65		1/4	521	(2)

Solenoid Valves / Pneumatic Valves (3/2) \blacktriangleleft (1)
 Direct or Pilot Operated Solenoid Valves / Pneumatic Valves (4/2 - 5/2 - 5/3) \blacktriangleleft (2)
 Solenoid Valves / Pneumatic Valves (3/2) \blacktriangleleft (3)
 Pressure Operated Valves (3/2) \blacktriangleleft (4)

All leaflets are available on: www.asco.com

00127GB-2018/R01
Availability, design and specifications are subject to change without notice. All rights reserved.

pipe connections										body material		max. operating pressure differential (bar)				fluid temperature range		power coil		series	page										
M5	1/8	1/4	3/8	1/2	3/4	1	1 1/4	1 1/2	2	2 1/2	3	Air operated version	SIL (IEC 61508)	ATEX / IECEx	brass	stainless steel	aluminium	orifice size (mm)	min. operating pressure differential (bar)			air	inert gases	water	oil	air	inert gases	water	oil	min.	max.
3/2 UNIVERSAL (U)																															
												-	4	Ex	///	///		5,7	0	10	10	10	10	-50	+120	1,85	1,8			327	1 (Ex db)
												-	3	Ex	///	///		12	0	10	-	10	-	-50	+90	14,1	14			327	1 (Ex db)
												-	4		///	///		5,7	0	10	10	10	10	-50	+120	3,7	3,6			327	(1)
												-	3		///	///		12	0	10	-	10	-	-50	+90	14,1	14			327	(1)
3/2 NORMALLY CLOSED (NC)																															
												-	4	Ex	///	///		5,7	0	10	10	10	10	-50	+120	1,8	1,5			327	www.asco.com
												-	4	Ex	///	///		5,7	0	10	10	10	10	-50	+120	1,8	1,5			327	www.asco.com
3/2 NORMALLY CLOSED (NC), VDI/VDE 3845, for linear actuator																															
												-	4	Ex	///	///		5,7	0	10	10	10	10	-50	+120	1,8	1,5			327	www.asco.com
												-	4	Ex	///	///		5,7	0	10	10	10	10	-50	+120	1,8	1,5			327	www.asco.com
3/2 UNIVERSAL, MANUAL RESET CONSTRUCTION																															
												-	4	Ex	///	///		5,7	0	10	10	10	10	-40	+120	3,7	3,2			327	www.asco.com
												-	-	Ex	///	///		12	0	10	-	10	-	-40	+90	10	11,2			327	www.asco.com
3/2 UNIVERSAL (U), REDUNDANT																															
												-	-	Ex	///	///		5,7	0	10	10	10	10	-50	+120	1,8	1,5			327	www.asco.com
												-	-	Ex	///	///		5,7	0	10	10	10	10	-50	+120	1,8	1,5			327	www.asco.com
3/2 NORMALLY CLOSED (NC) - 5/2																															
												↑	4	Ex	///	///		6	2 (0)	10	-	10	-	-40 ⁽¹⁾	+40	0,4	0,03			551	(2)
												↑	3	Ex	///	///		13	2 (0)	10	-	10	-	-25	+60	10,5	11,2			553	(2)
												↑	4	Ex	///	///		6	2	8	-	8	-	-20	+60	2,5	3			521	(2)
												↑	4	Ex	///	///		6	2 (0)	10	-	10	-	-40	+60	1,1	0,003			551	(2)
												↑	4	Ex	///	///		6	2 (0)	10	-	10	-	-40	+80	1,5	0,4			551	www.asco.com
												↑	3	Ex	///	///		13	2 (0)	10	-	10	-	-40	+60	10,5	11,2			553	www.asco.com
												↑	4	Ex	///	///		6	2 (0)	10	-	10	-	-40 ⁽¹⁾	+40	0,4	0,03			551	(1) (2)
												↑	3	Ex	///	///		13	2 (0)	10	-	10	-	-25	+60	10,5	11,2			553	(1) (2)
												↑	4	Ex	///	///		6	2 (0)	10	-	10	-	-40	+60	1,1	0,003			551	(1) (2)
												↑	4	Ex	///	///		6	2 (0)	10	-	10	-	-40	+80	1,5	0,4			551	www.asco.com
												↑	3	Ex	///	///		13	2 (0)	10	-	10	-	-40	+60	10,5	11,2			553	www.asco.com
5/3																															
												-	-	Ex	///	///		6	2 (0)	10	-	10	-	-40	+40	1,1	1,2			551	(2)
												-	-	Ex	///	///		13	2 (0)	10	-	10	-	-40	+60	10,5	11,2			553	(2)
												-	-	Ex	///	///		6	2 (0)	10	-	10	-	-25	+40	1,1	1,2			551	(2)
												-	-	Ex	///	///		13	2 (0)	10	-	10	-	-25	+60	10,5	11,2			553	(2)
												-	-	Ex	///	///		6	2 (0)	10	-	10	-	-40	+80	1,5	0,4			551	www.asco.com
												-	-	Ex	///	///		13	2 (0)	10	-	10	-	-40	+80	10,5	11,2			551	www.asco.com

Solenoid Valves / Pneumatic Valves (3/2) ▲⁽¹⁾
 Direct or Pilot Operated Solenoid Valves / Pneumatic Valves (4/2 - 5/2 - 5/3) ▲⁽²⁾
 Solenoid Valves / Pneumatic Valves (3/2) ▲⁽³⁾
 Pressure Operated Valves (3/2) ▲⁽⁴⁾

All leaflets are available on: www.asco.com

ASCO offers a wide range of products for the process industry such as the oil & gas, (petro)chemical, pharmaceutical, power generation, water/waste water, food and paper & pulp sectors.

Solenoid pilot valves are used to activate single-acting or double-acting pneumatic actuators operating as the driving force on process valves. Quality and reliability of the process valves are paramount for production line safety and output.

The products are often installed in environments with low or high temperatures, corrosive atmospheres, or high mechanical stress. They must be designed to provide a high level of long-term reliability under severe operating conditions.

Our catalogue "Pilot Valves and Systems for the Process Industry" details the full line of our process industry products adapted to your specific sector of activity.

You will find our complete range of solenoid valves, pressure operated valves and pneumatic components on the internet at www.asco.com.

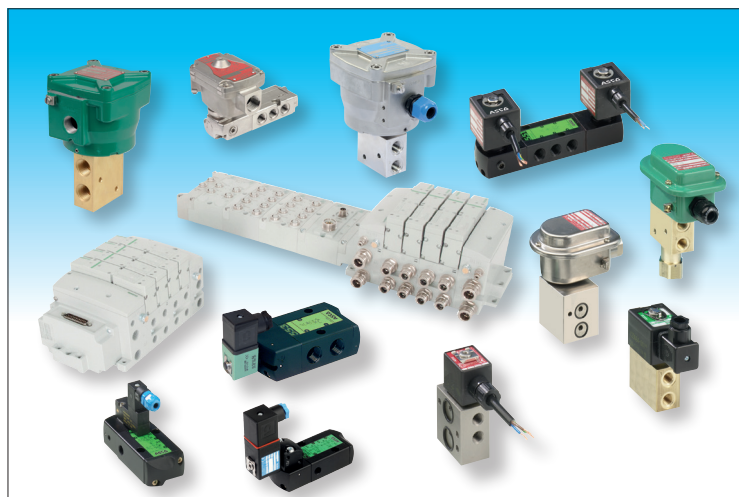

To provide you with the best solution for your application needs, ASCO offers a variety of exclusive pilot valve features including:

- Intrinsic safety
- Low power consumption
- Namur mounting pad
- Safety shutdown systems

Our low power solenoid valves are compliant with all major communication protocols such as: DeviceNet™, EtherNet/IP™, Profibus DP, PROFINET, ModbusTCP and Foundation Fieldbus

Our pilot valves are available in a large selection of versions:

- 3x2-, 4- and 5-way direct acting or pilot operated valves
- Brass, stainless steel, aluminium or plastic bodies
- Seals in a wide choice of elastomers
- Solenoid valves for use in potentially explosive atmospheres to ATEX designed to operate at temperatures from -60°C to +100°C.

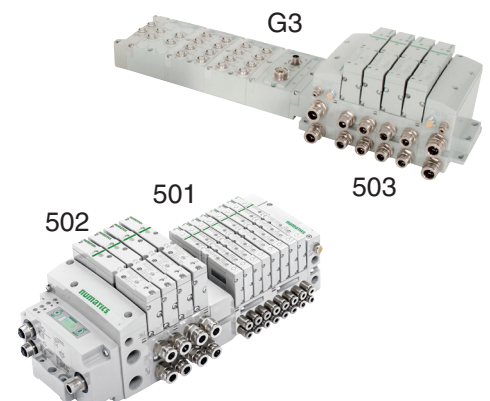

00127GB-2018/R01
Availability, design and specifications are subject to change without notice. All rights reserved.

All leaflets are available on: www.asco.com

To meet both environmental standards and actuator requirements, pilot valves need to be selected with care, with reference to:

- Mounting interface
- Flow capacity
- Function
- Choice between direct-acting or pilot operated valves
- Functional safety
- Power consumption and type of electrical connection
- Communication through fieldbus and remote I/O
- Environment: Temperature, humidity, aggressive atmospheres, potentially explosive atmospheres, and protection rating

Different types of pneumatic actuators: rack & pinion, scotch yoke, linear etc.

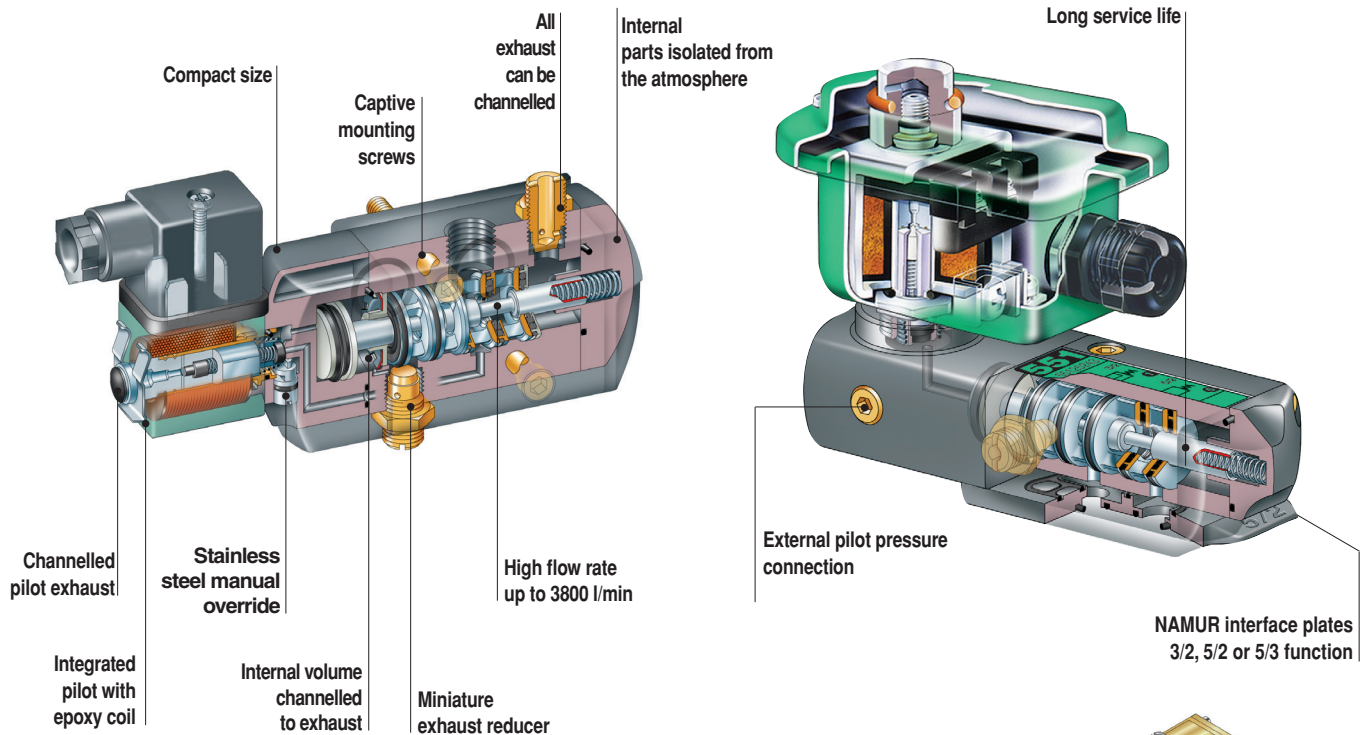
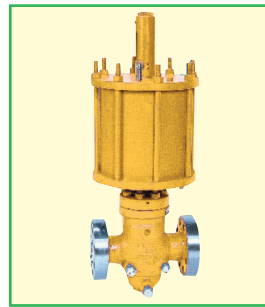
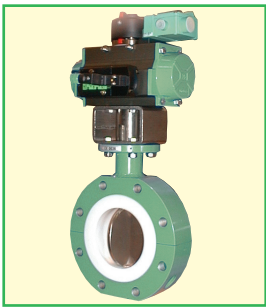

Clean/aggressive environments

All the exhaust ports are pipable for environment protection.

The solenoid valve's internal volumes are channelled to the exhaust port to prevent the risk of corrosion in aggressive atmospheres. In NAMUR version, the spring-return chamber of the single-acting actuator "breathes" through the solenoid valve, isolating it from the outside atmosphere.

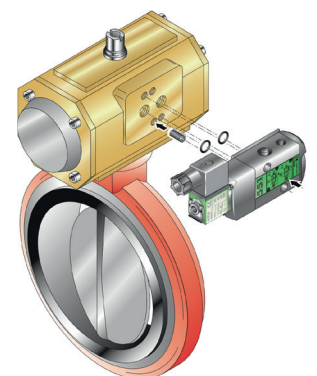

551 and 553 Series

- A unique range of 1/4" and 1/2" pilot operated solenoid valves for your pneumatic actuator applications.
 - Small size and high flow rate up to 3800 l/min
 - NAMUR and threaded versions
 - Intrinsic safe version
 - Fieldbus compatible
 - Suitable for use in hazardous area zones 0, 1, 2, 20, 21, 22
- Wide range of pilot valves and solenoid operators, available with different power levels, valve materials, piloting interfaces and functions (3/2, 5/2, 5/3) to meet your needs for safety and low power consumption.
- NAMUR versions are in accordance with CEN/TC69/WG1/SG10 and VDI/VDE3845 (NAMUR).
- The monostable spool valves in conformity with IEC 61508 Standard (2010 route 2_H version) have TÜV (551 series) and EXIDA (551-553 series) certified with integrity levels: SIL 2 for HFT = 0 / SIL 3 for HFT = 1
- General characteristics (according to version):
 - Max. operating pressure: 10 bar
 - Operating temperature range: -40°C to +80°C
 - Flow: 700 l/min to 3800 l/min

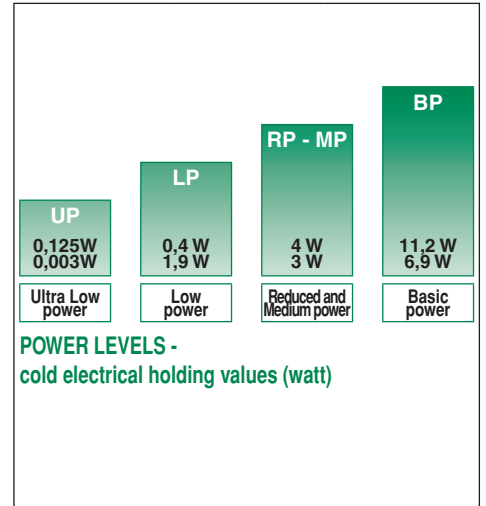

See Quick Selection Chart

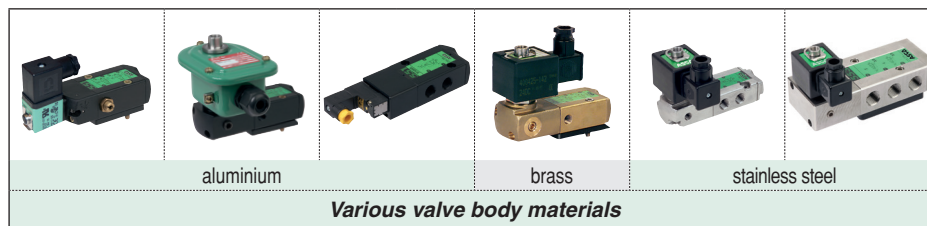

To reduce the total cost of installation, enhance the reliability of solenoid valves and make them suitable for fieldbus control, there is a strong trend towards low power design.

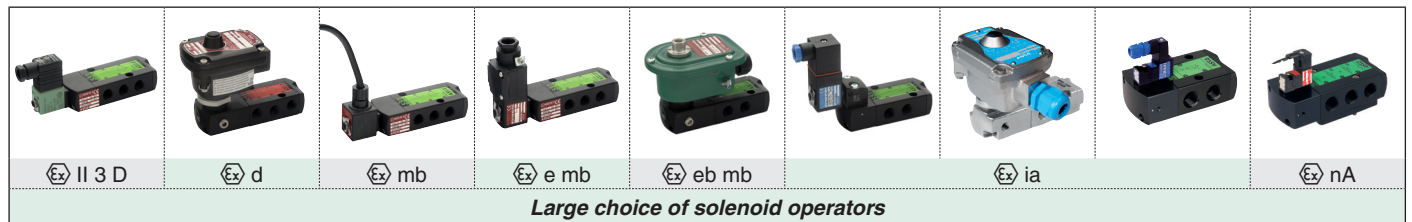

Series 327

- Series 327 1/4" - 1/2" direct acting solenoid valve are recommended for pilot applications with high flow, a wide pressure range and no minimum operating pressure.
- The balanced poppet design combines a special low friction seal with low power consumption.
- Functional safety levels: SIL 3, IEC 61508
- General characteristics (brass, aluminium or stainless steel bodies):
 - Orifice size = 5,7 mm (1/4), 12 mm (1/2)
 - Temperature range: -60°C to +120°C
 - Manual Operators are optional including an under pressure removable type
 - Standard or tamperproof manual reset, NAMUR versions, redundant solenoid valves, for linear actuators (VDE 3845).
- Environmental NACE compliant and certified vibration resistant in combination with WSCR solenoids

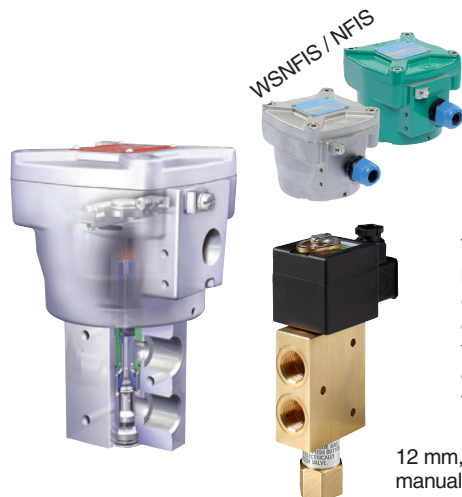
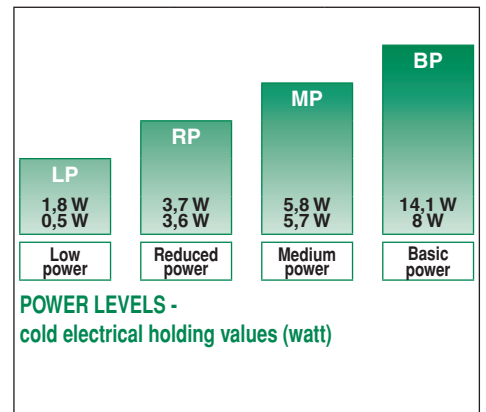

The balanced poppet design provides a uniform pressure field around the poppet that prevents any resistance to pressure when the valve opens. The coil therefore only has to offset the friction of the seal.



All leaflets are available on: www.asco.com

00127GB-2018/R01 Availability, design and specifications are subject to change without notice. All rights reserved.



SOLENOID VALVES

direct operated, balanced poppet
high flow, flameproof enclosure
II 2 G/D Ex db IIC T6..T4 Gb / Ex tb IIIC Db IP66/67
1/4 - 1/2

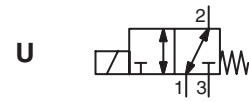

3/2
Series
327

FEATURES

- Solenoid valves with explosionproof operators NF or WSNF type for use in potentially explosive atmospheres according to ATEX Directive 2014/34/EU EU type examination certificate no.: **LCIE 00 ATEX 6008 X** IECEx Certificate of Conformity no.: **IECEx LCI 07.0015X**
- Compliance with the Essential Health and Safety Requirements has been assured by compliance with the International and European Standards EN-IEC 60079-0, EN-IEC 60079-1 and EN-IEC 60079-31
- The solenoid valves are recommended for pilot applications with high flow, wide pressure ranges and no minimum operating pressure
- Special execution for low ambient and fluid temperatures
- Manual Operators are optional including an under pressure removable type
- The valves are certified according to IEC 61508 Functional Safety data and have SIL-3 capability (TUV & Exida certification)

GENERAL

Differential pressure 0 - 10 bar [1 bar = 100 kPa]
Maximum viscosity 65 cSt (mm²/s)
Response time < 100 ms

fluids (*)		temperature range (TS)	seal materials (*)
5,7 mm	air, inert gas, water, oil	- 20°C to + 120°C	FPM (fluoroelastomer)
		- 40°C to + 40°C	VMQ (silicone)
		- 60°C to + 60°C	(F)VMQ ((fluoro)silicone)
12 mm	air, inert gas	- 25°C to + 60°C	NBR (nitrile)
		- 10°C to + 90°C	FPM (fluoroelastomer)
		- 50°C to + 60°C	(F)VMQ ((fluoro)silicone)

MATERIALS IN CONTACT WITH FLUID

(*) Ensure that the compatibility of the fluids in contact with the materials is verified

Body Brass or stainless steel AISI 316L
Stem, core tube Stainless steel
Core and plugnut Stainless steel
Springs Stainless steel
Seals & poppets Ø 5,7 mm: FPM or VMQ or (F)VMQ
Ø 12 mm: NBR or FPM or (F)VMQ
Rider ring PTFE

OTHER MATERIALS

Solenoid enclosure NF: Chromated aluminium, epoxy coated
WSNF: Stainless steel (AISI 316L)
Bonnet, cover screws NF: Steel (zinc plated)
WSNF: Stainless steel
Core tube Stainless steel
Core and plugnut Stainless steel

ELECTRICAL CHARACTERISTICS

Coil insulation class H (5,7 mm), F (12 mm)
Coil connection Screw terminals
Electrical safety IEC 60335-1
Standard voltages DC (=) : 24V - 48V
AC (~) : 24V - 48V - 115V - 230V / 50 Hz

SAFETY CODE

IECEx / II 2G Ex db IIC T6..T4 Gb
IECEx / II 2D Ex tb IIIC 85°C to 135°C Db IP66/67

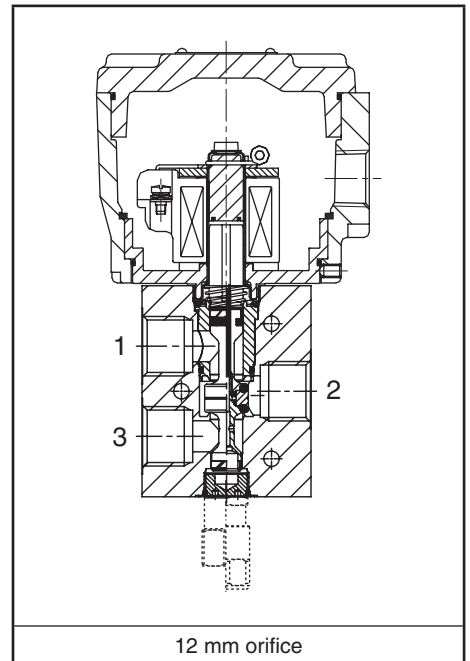

prefix option	power ratings				operator ambient temperature range (TS) (C°) ⁽³⁾	replacement coil		type ⁽¹⁾	
	inrush ~	holding ~		hot/cold =		~	=		
		(VA)	(VA)						(W)
NF	5,7	10	10	10	9 / 11,2	-60 to + 40/60	400915-017	400913-142	01-02
		5,8	5,8	5,8	5,2 / 5,7	-60 to + 60/75/90	400921-297	400914-442	
		3,7	3,7	3,7	3,2 / 3,6	-60 to + 60	⁽²⁾	400914-242	
		1,85	1,85	1,85	1,5 / 1,8	-60 to + 55	⁽³⁾	400914-542	
WSNF	12	10	10	10	9 / 10	-60 to + 40/60	400921-197	400911-342	01-02
		14,1	14,1	14,1	11 / 14	-60 to + 40/60/90	400921-697	400911-642	

⁽¹⁾ Refer to the dimensional drawings on the following page.

⁽²⁾ AC limited to 127V/50/60Hz or 125V/DC
⁽³⁾ Temperature range can be limited by sealings.
⁽⁴⁾ Only available in 24, 48 and 110V/DC

Pn (W)	operator AC (~)		
	max. ambient temp. °C surface temperature		
	T6 85°C	T5 100°C	T4 135°C
1,85 ⁽⁴⁾	55	-	-
3,7 ⁽⁴⁾	60	-	-
5,8 ⁽⁴⁾	60	75	90
10 ⁽⁴⁾	40	60	-
14,1	40	60	90

Pn (W)	operator DC (=)		
	max. ambient temp. °C surface temperature		
	T6 85°C	T5 100°C	T4 135°C
1,8	55	-	-
3,6	60	-	-
5,7	60	75	90
10	40	60	-
11,2	40	60	-
14	40	60	90

⁽⁴⁾ AC rectified coil construction.

All leaflets are available on: www.asco.com

00197GB-2018/R01 Availability, design and specifications are subject to change without notice. All rights reserved.



青岛秉诚自动化设备有限公司
地址：中国·青岛市重庆南路99号海尔云街甲3号楼7F

服务热线：4006-918-365
网址：http://www.ivalve.com

Process Industry - 1
传真：(86-532)585-10-365
Email：sales@bechinas.com

SPECIFICATIONS

pipe size	orifice size	flow coefficient Kv		operating pressure differential (bar)				power coil (W)		catalogue number		options				
				min.	max. (PS)		maintained man. operator (2)					impulse man. operator (2)				
					air (*)	water (*)										
NPT	(mm)	(m³/h)	(l/min)	~	=	~	=	~	=	~/=	~/=					
U - Universal, FPM seals and poppets																
1/4	5,7	0,45	7,5	0	10	10	10	10	10	11,2	NF8327B001	WSNF8327B002	MS ⁽¹⁾	MO	-	-
									5,8	5,7	NF8327B201	WSNF8327B202	MS ⁽¹⁾	MO	-	-
									3,7	3,6	NF8327B101	WSNF8327B102	MS ⁽¹⁾	MO	-	-
									1,85	1,8	NF8327B301	WSNF8327B302	MS ⁽¹⁾	MO	-	-
1/2	12	1,5	25	0	10	10	-	-	14,1	14	NF8327A649	WSNF8327A650	MS ⁽¹⁾	MO	-	-
									14,1	14	NF8327A609	WSNF8327A610	MS ⁽¹⁾	MO	-	-
U - Universal, NBR seals and poppets																
1/2	12	1,5	25	0	10	10	-	-	10	10	NF8327A607	WSNF8327A608	MS ⁽¹⁾	MO	-	-
U - Universal, VMQ seals and poppets																
1/4	5,7	0,45	7,5	0	10	10	10	10	10	11,2	NF8327B011	WSNF8327B012	MS ⁽¹⁾	MO	-	-
U - Universal, (F)VMQ seals and poppets																
1/4	5,7	0,45	7,5	0	10	10	10	10	5,8	5,7	NF8327B211	WSNF8327B212	MS ⁽¹⁾	MO	-	-
									3,7	3,6	NF8327B111	WSNF8327B112	MS ⁽¹⁾	MO	-	-
									1,85	1,8	NF8327B311	WSNF8327B312	MS ⁽¹⁾	MO	-	-
1/2	12	1,5	25	0	10	10	-	-	10	10	NF8327A645	WSNF8327A646	MS ⁽¹⁾	MO	-	-
									10	10	NF8327A605	WSNF8327A606	MS ⁽¹⁾	MO	-	-
U - Universal, (F)VMQ sealings and poppets (minimum fluid temperature -60°C)																
1/4	5,7	0,45	7,5	0	10	10	10	10	5,8	5,7	NF8327B291	WSNF8327B292	MS ⁽¹⁾	MO	-	-

⁽¹⁾ Functional Safety certification is not applicable with this feature.

⁽²⁾ Under pressure removable execution

OPTIONS

- Waterproof enclosure with embedded screw terminal coil according to protection class IP67, CEE-10
- Explosionproof enclosures for use in zones 1/21-2/22, categories 2-3 to ATEX Directive 2014/34/EU (www.asco.com)
- Electrical enclosures according to "NEMA" standards are available
- Compliance with "UL", "CSA" and other local approvals available on request
- 3/8" pipe thread executions are available on request
- Stainless steel exhaust protector for valves certified to IEC 61508 Functional Safety, catalogue number: **131875-015** (NPT 1/4) or **131875-013** (NPT 1/2)
- Other pipe connections are available on request
- Any ATEX approved cable entry device can be fitted in the 1/2" NPT threaded entry hole (M20 x 1.5 in option), refer to the nameplate for identification of the maximum cable temperature
- Material certification like EN 10204 3.1 on the 316L Stainless Steel bodies are available on request

INSTALLATION

- The solenoid valves can be mounted in any position without affecting operation
- Solenoid valves have 2 or 3 mounting holes in body
- 1/2" NPT threaded cable entry. Enclosures are supplied without cable gland
- Pipe connection identifier is 8 = NPT (ANSI 1.20.3)
- Installation/maintenance instructions are included with each valve

SPARE PARTS KIT

catalogue number	spare parts kit no.
(WS)NF8327B001/002	C123670
(WS)NF8327B011/012	C131237
(WS)NF8327B101/102/201/202	C132251
(WS)NF8327B111/112/211/212	C132253
(WS)NF8327B301/302	C133441
(WS)NF8327B311/312	C133442
(WS)NF8327A605/606/645/646	C117638
(WS)NF8327A607/608	C117640
(WS)NF8327A609/610/649/650	C117640V

ORDERING EXAMPLES:

NF	8	327	B	001	230V / 50 Hz
WSNF	8	327	B	202	MS 115V / 50 Hz
NF	8	327	A	607	MO 24V / DC
NF	8	327	A	606	230V / 50 Hz

prefix _____
 pipe thread _____
 basic number _____
 voltage _____
 suffix _____

ORDERING EXAMPLES KITS:

C123670	
C131237	
C117640	V

basic number _____
 suffix _____

All leaflets are available on: www.asco.com

DIMENSIONS (mm), WEIGHT (kg)

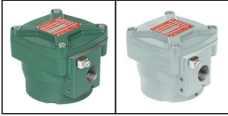

TYPE 01-02

Prefix "NF", "WSNF" Solenoid
Aluminium, stainless steel
EN-IEC 60079-1 and EN-IEC 60079-31
II 2G Ex db IIC Gb, II 2D Ex tb IIIC Db IP66/67

Type 01: NF8327B001/011/101/111/201/211/291/301/311

Type 02: WSNF8327B002/012/102/112/202/212/292/302/312

Type 01: NF8327A605/607/609/645/649

Type 02: WSNF8327A606/608/610/646/650

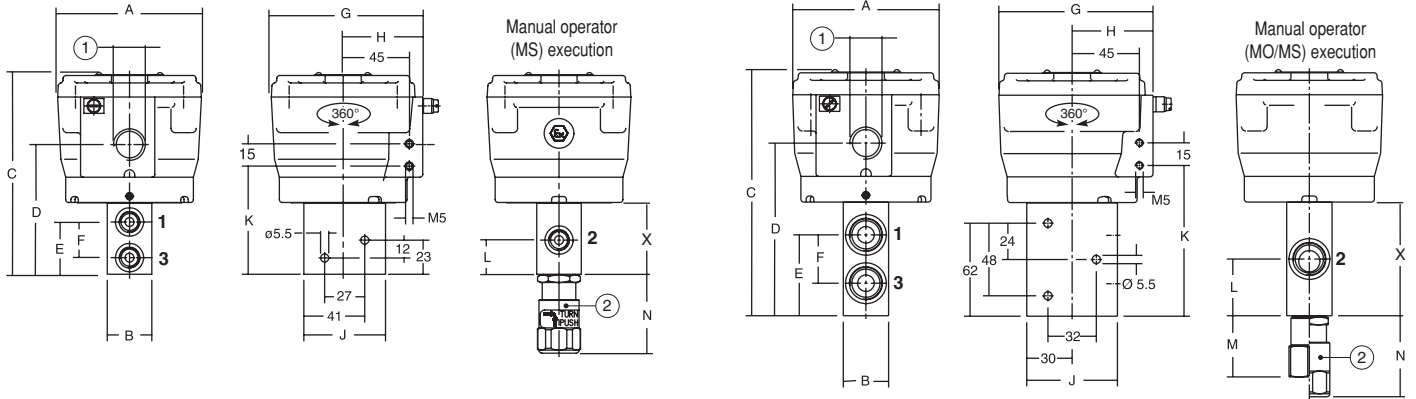

- ① 1/2 NPT
- ② Manual operator location

type	prefix option	catalogue number	A	B	C	D	E	F	G	H	J	K	L	M	N	X	weight ⁽¹⁾
01	NF	NF8327B001/011/101/111/201/211/291/301/311	97	30	136	87	35	24	102	54	55	73	23	-	54	48	2,6
		NF8327A605/607/609/645/649	97	30	165	115	54	32	102	54	60	100	38	40	54	76	2,4
02	WSNF	WSNF8327B002/012/102/112/202/212/292/302/312	97	30	136	87	35	24	102	54	55	73	23	-	54	48	2,6
		WSNF8327A606/608/610/646/650	97	30	165	115	54	32	102	54	60	100	38	40	54	76	3,8

⁽¹⁾ including coil.

